

Kit 1508

FORD F-250/350, 4-dr Super Cab, 99–
FORD F-250/350, 4-dr Crew Cab, 99–

480R
754

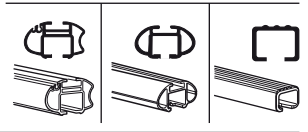
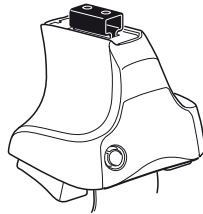

480

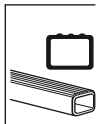
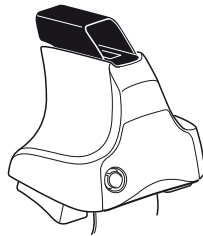

750

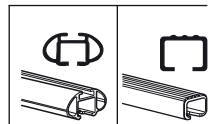
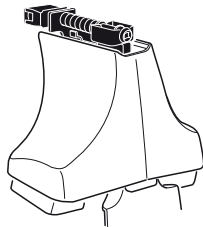

x2 x2 x2 x4	x2	x2 x2 x4 x4	x2 x2 x2	x2	x2

1008 x 4

65 x 4

x 1

Kit



3



754

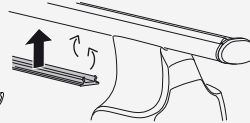
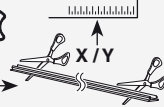

750



1

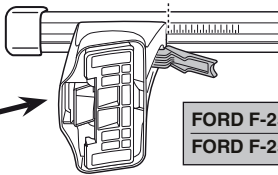
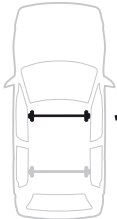

2

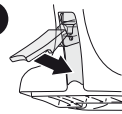

	X	
FORD F-250/350, 4-dr Super Cab, 99–	63,5	
FORD F-250/350, 4-dr Crew Cab, 99–	63,5	

1

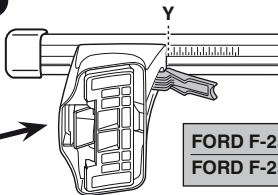
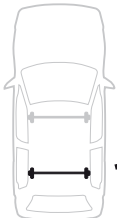

2

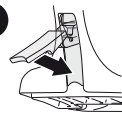

	Y	
FORD F-250/350, 4-dr Super Cab, 99–	63,5	
FORD F-250/350, 4-dr Crew Cab, 99–	63,5	



480R



480

1

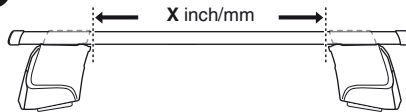

2

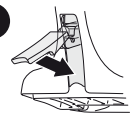

	X inch	X mm
FORD F-250/350, 4-dr Super Cab, 99–	50 1/2"	1286 mm
FORD F-250/350, 4-dr Crew Cab, 99–	50 1/2"	1286 mm

1

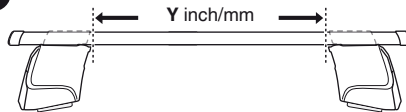

2

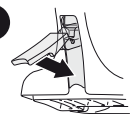

	Y inch	Y mm
FORD F-250/350, 4-dr Super Cab, 99–	50 1/2"	1286 mm
FORD F-250/350, 4-dr Crew Cab, 99–	50 1/2"	1286 mm

4

FORD F-250/350, 4-dr Super Cab, 99–
 FORD F-250/350, 4-dr Crew Cab, 99–

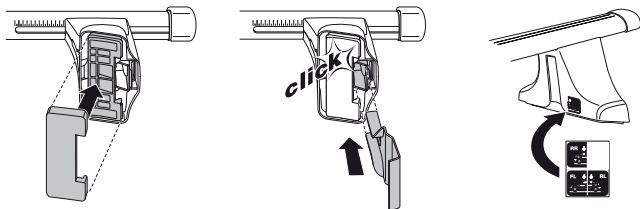
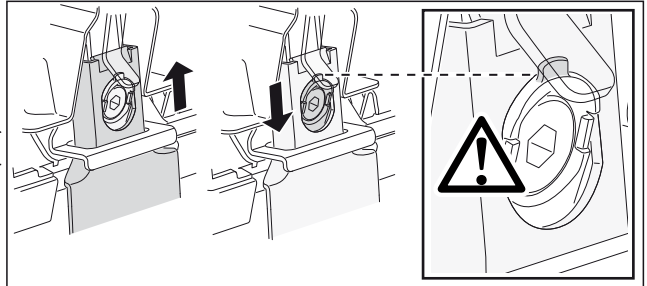
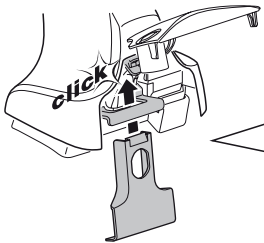
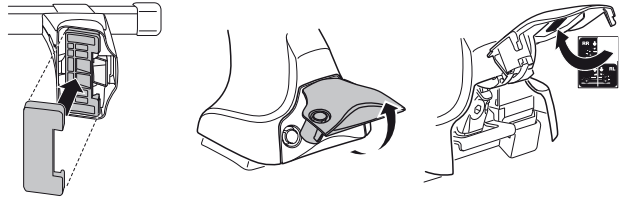
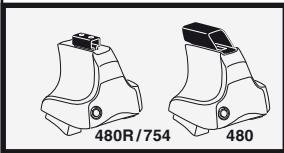
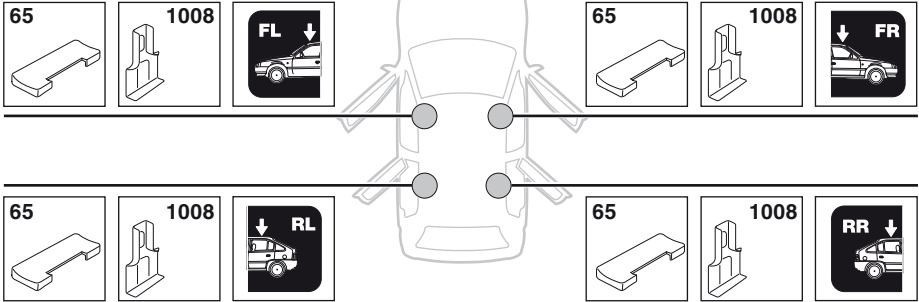

5



	X mm	Y mm	X inch	Y inch
FORD F-250/350, 4-dr Super Cab, 99–	216 mm	800 mm	8 1/2"	31 1/2"
FORD F-250/350, 4-dr Crew Cab, 99–	216 mm	800 mm	8 1/2"	31 1/2"

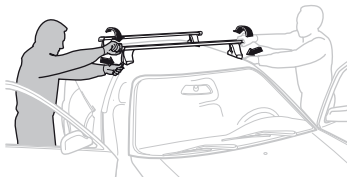
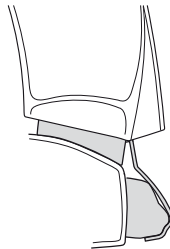
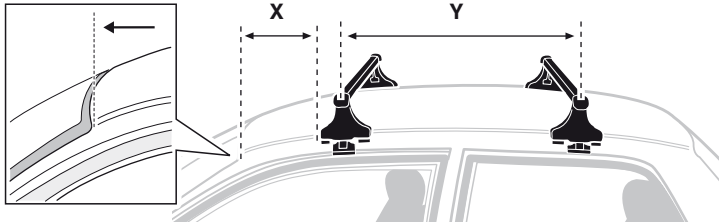

GB/US Tighten alternately

D Die Schrauben abwechselnd anziehen

F Serrer alternativement chaque côté

NL Afwisselend aan de linker- en de rechterkant aandraaien

I Alternare il serraggio delle viti

E Serrare alternativamente

PT Aperte alternadamente

S Dra åt växelvis

FIN Kierrä vuorotellen

EST Pinguldage vaheldumisi

LAT Pielieciet pamišus

LIT Užsukinėkite pakaitomis

PL Śruby dokręcaj naprzemiennie

RU Затягивайте попеременно

CZ Pokręťta багаžníka dokręcaj dokręcaj naprzemiennie.

SK Doťahujte striedavo

SLO Privijajte izmenično.

HR Naizmjenično zategnite

HU Egymástól függetlenül szorítandó

GR Σφιγγετε εναλλάξ

TR Dönüşümlü sıkın

中文 交替拧紧

한국어 번갈아 가며 조이십시오.

日本語 交互に締め付けてください。

ไทย ชั้้นแบบสลับ

6



480R/754



480

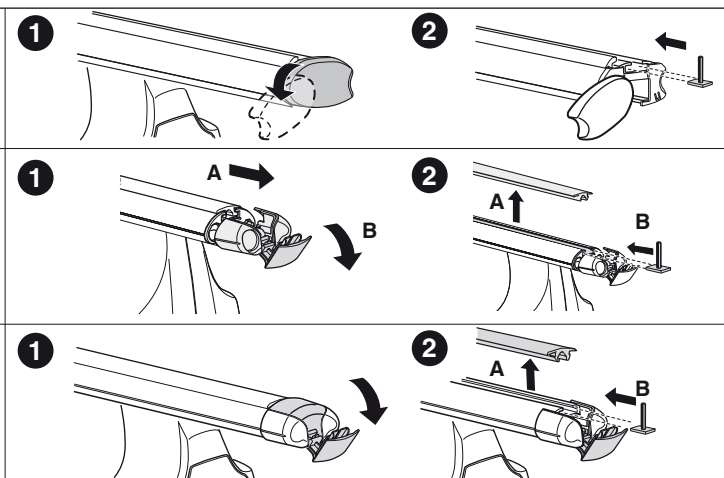
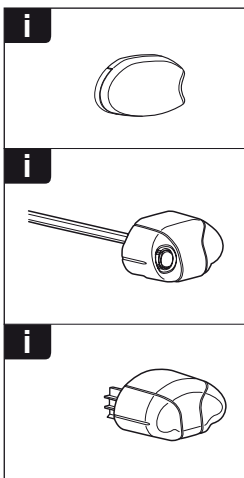
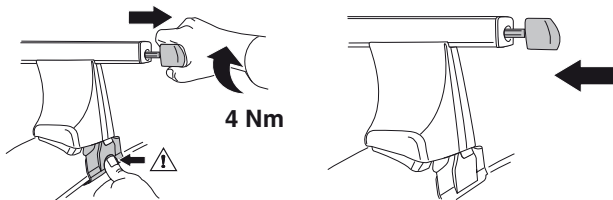
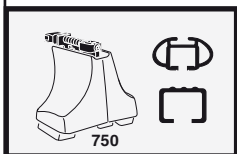
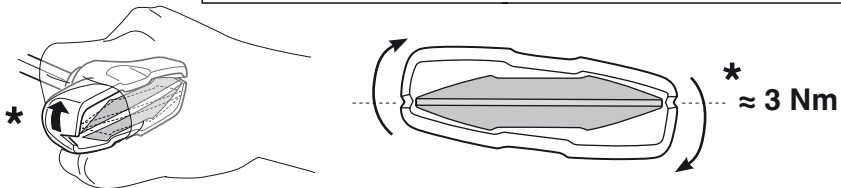
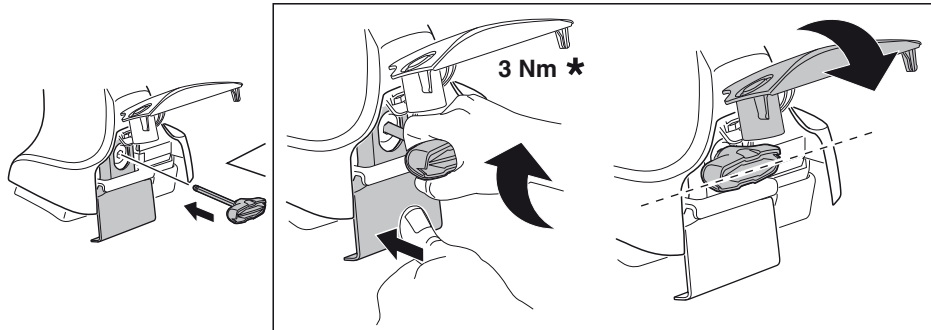

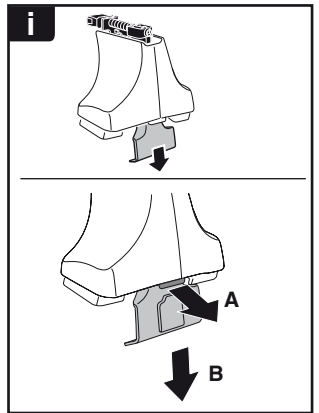
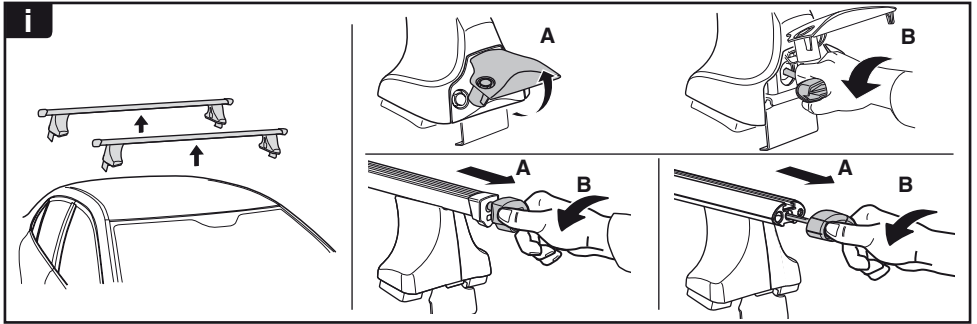

THULE
SWEDEN
**ONE
KEY
SYSTEM**



		(x4)
		(x6)
		(x8)
NA		(x10)
EUR		(x12)
ASIA		(x12)



WW ▶ Thule Sweden AB, Box 69, 330 33 Hillerstorp, SWEDEN
NA ▶ Thule Inc., 42 Silvermine Road, Seymour, Connecticut 06483, USA

info@thule.com
customer.service@thule.com

www.thule.com