

# Kit 1511

TOYOTA Tacoma, 4-dr Pickup Extended Cab, 05–  
TOYOTA Tacoma, 4-dr Pickup Quad Cab, 05–

480R  
754

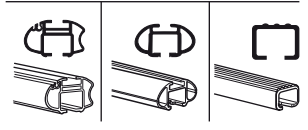
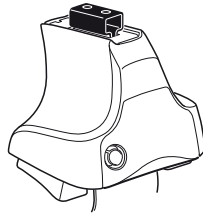

480

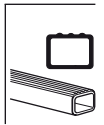
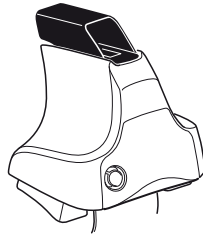

750

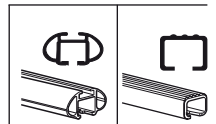
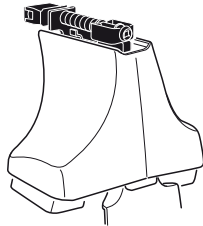

**Kit**



**3**

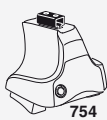

754

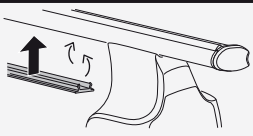
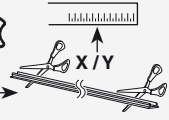

750

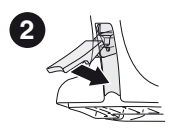
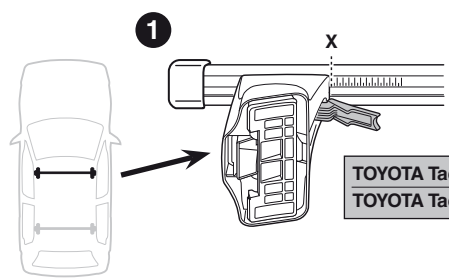

	X
TOYOTA Tacoma, 4-dr Pickup Extended Cab, 05-	44
TOYOTA Tacoma, 4-dr Pickup Quad Cab, 05-	44

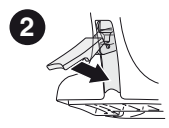
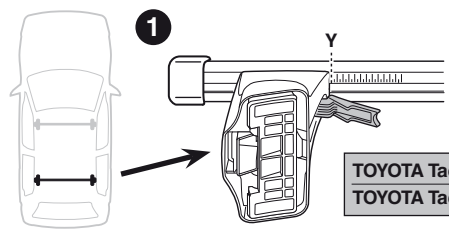

	Y
TOYOTA Tacoma, 4-dr Pickup Extended Cab, 05-	44
TOYOTA Tacoma, 4-dr Pickup Quad Cab, 05-	44



480R



480

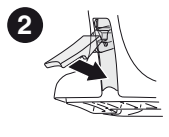
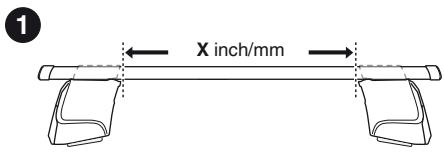

	X inch	X mm
TOYOTA Tacoma, 4-dr Pickup Extended Cab, 05-	43"	1091 mm
TOYOTA Tacoma, 4-dr Pickup Quad Cab, 05-	43"	1091 mm

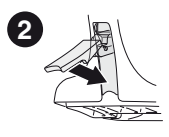
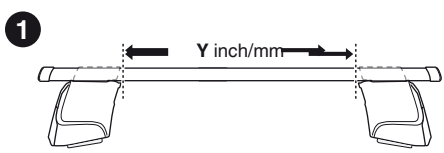
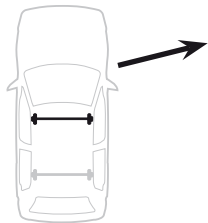

	Y inch	Y mm
TOYOTA Tacoma, 4-dr Pickup Extended Cab, 05-	43"	1091 mm
TOYOTA Tacoma, 4-dr Pickup Quad Cab, 05-	43"	1091 mm

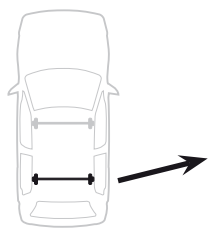

# 4

TOYOTA Tacoma, 4-dr Pickup Extended Cab, 05–  
 TOYOTA Tacoma, 4-dr Pickup Quad Cab, 05–

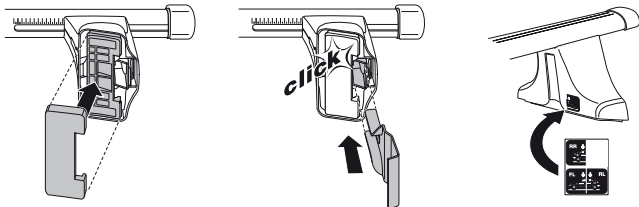
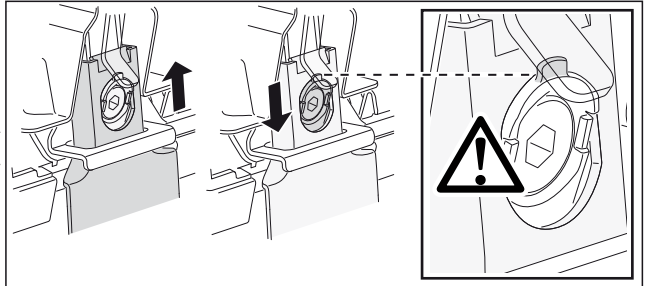
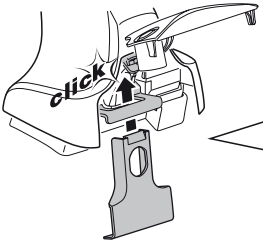
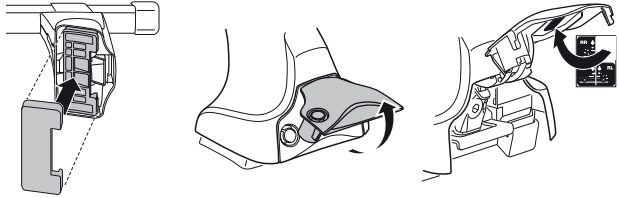
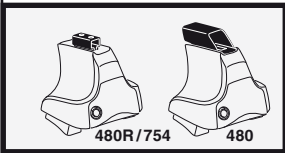
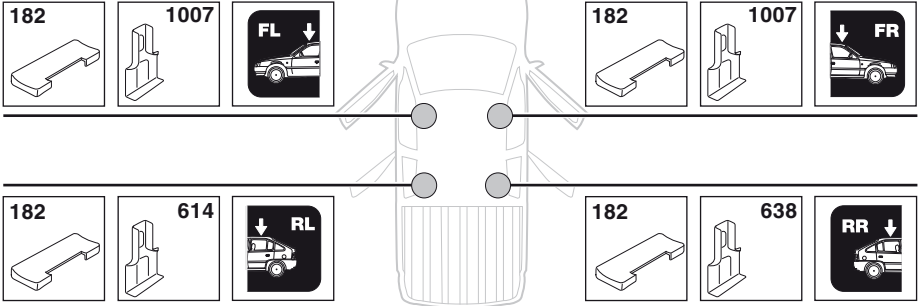

5



	X mm	Y mm	X inch	Y inch
TOYOTA Tacoma, 4-dr Pickup Extended Cab, 05–	330 mm	985 mm	13"	38 3/4"
TOYOTA Tacoma, 4-dr Pickup Quad Cab, 05–	330 mm	985 mm	13"	38 3/4"

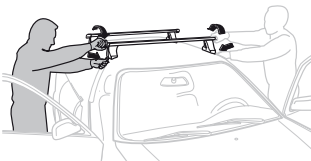
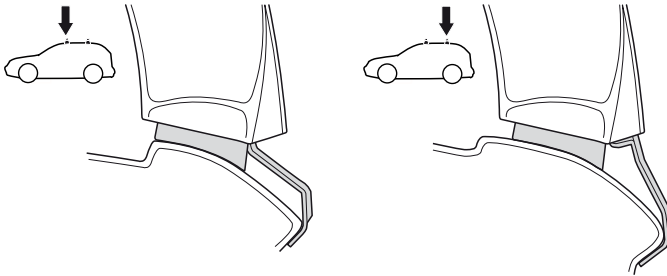
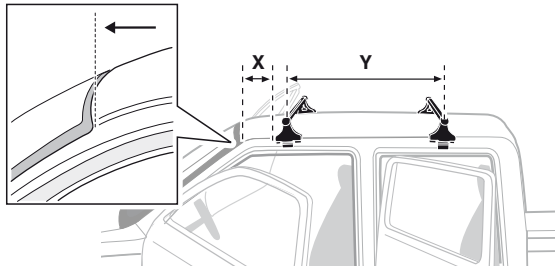

- |              |   |            |   |
|--------------|---|------------|---|
| <b>GB/US</b> | Tighten alternately                                     | <b>CZ</b>  | Pokrétla багаžníka dokrčejaj dokrčejaj naprzemiennie. |
| <b>D</b>     | Die Schrauben abwechselnd anziehen                      | <b>SK</b>  | Dofahajte striedavo                                   |
| <b>F</b>     | Serrer alternativement chaque côté                      | <b>SLO</b> | Privijajte izmenično.                                 |
| <b>NL</b>    | Afwisselend aan de linker- en de rechterkant aandraaien | <b>HR</b>  | Naizmjениčno zategnite                                |
| <b>I</b>     | Alternare il serraggio delle viti                       | <b>HU</b>  | Egymástól függetlenül szorítandó                      |
| <b>E</b>     | Serrare alternativamente                                | <b>GR</b>  | Σφιγίγτε εναλλάξ                                      |
| <b>PT</b>    | Aperte alternadamente                                   | <b>TR</b>  | Dönüşümlü sıkın                                       |
| <b>S</b>     | Dra åt växelvis   | <b>中文</b>  | 交替拧紧  |
| <b>FIN</b>   | Kierrä vuorotellen                                      | <b>한국어</b> | 변갈아 가며 조이십시오.   |
| <b>EST</b>   | Pinguldage vaheldumisi                                  | <b>日本語</b> | 交互に締め付けてください。   |
| <b>LAT</b>   | Pielvelciēt pamišus                                     | <b>ไทย</b> | ขันในแบบสลับ  |
| <b>LIT</b>   | Užsukinėkite pakaitomis                                 |            |   |
| <b>PL</b>    | Śruby dokrčejaj naprzemiennie                           |            |   |
| <b>RU</b>    | Затягивайте попеременно                                 |            |   |

6



480R/754



480

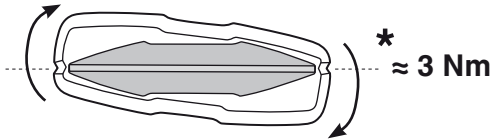
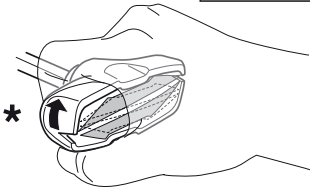
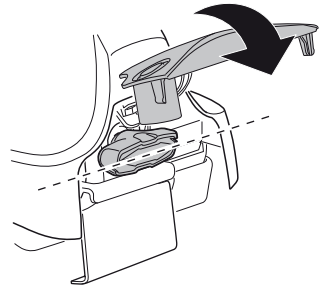
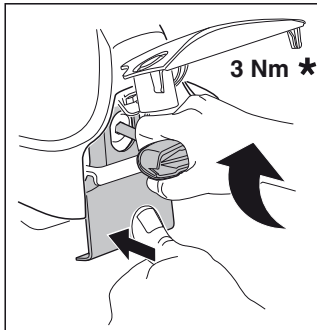
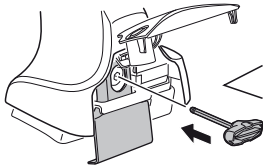

750

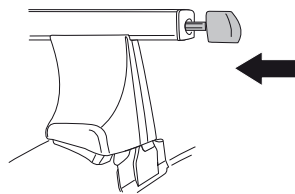
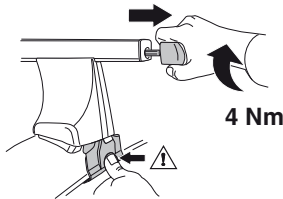

i



1

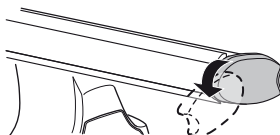

2

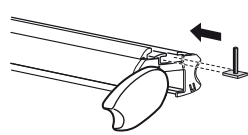

i

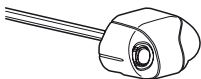

1

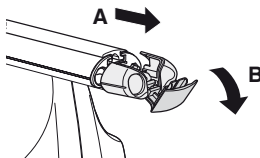

2

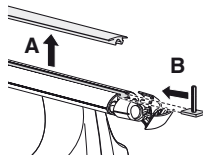

i



1

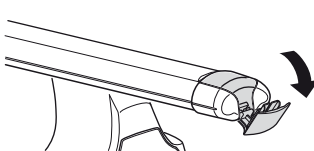

2

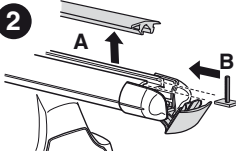



**THULE**  
SWEDEN  
**ONE  
KEY  
SYSTEM**



- 544 (x4)
- 596 (x6)
- 588 (x8)
- NA 510 (x10)
- EUR
- ASIA 452 (x12)



WW ▶ Thule Sweden AB, Box 69, 330 33 Hillerstorp, SWEDEN  
NA ▶ Thule Inc., 42 Silvermine Road, Seymour, Connecticut 06483, USA

info@thule.com  
customer.service@thule.com

www.thule.com