

# Kit 1549

ACURA MDX, 5-dr SUV, 07- \*

\* w/o factory rack

480R  
754

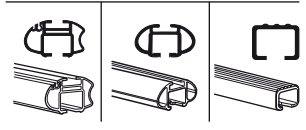
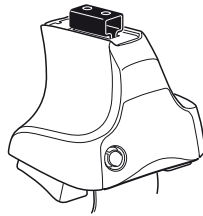

480

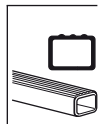
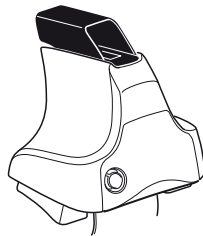

750

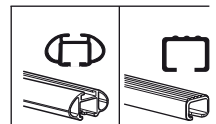
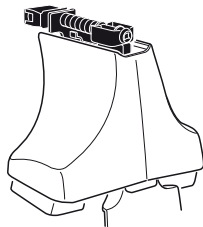

**Kit**



**3**



754

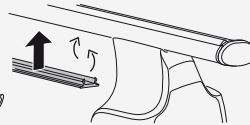
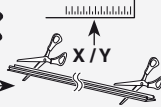

750



**1**

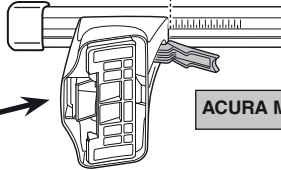
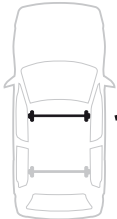

**2**

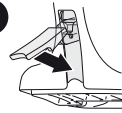

**ACURA MDX, 5-dr SUV, 07-**

**X**

**53**

**1**

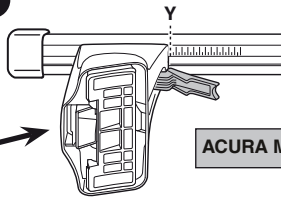
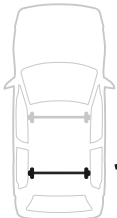

**2**

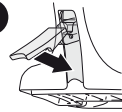

**ACURA MDX, 5-dr SUV, 07-**

**Y**

**46**



480R



480

**1**

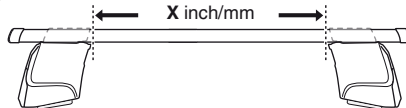

**2**

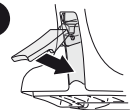

**ACURA MDX, 5-dr SUV, 07-**

**X inch**

**46 1/2"**

**X mm**

**1181 mm**

**1**

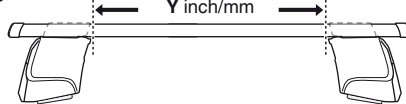

**2**



**ACURA MDX, 5-dr SUV, 07-**

**Y inch**

**43 3/4"**

**Y mm**

**1111 mm**

# 4

ACURA MDX, 5-dr SUV, 07-

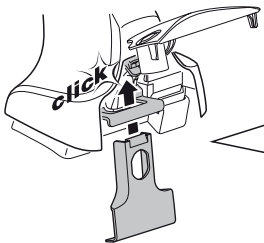
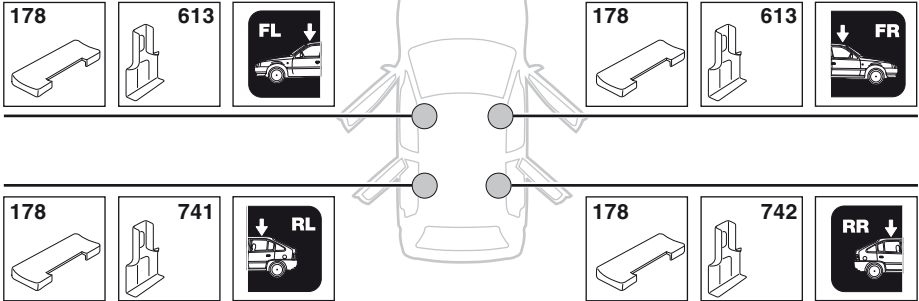

5



	X mm	Y mm	X inch	Y inch
ACURA MDX, 5-dr SUV, 07–	279 mm	724 mm	11"	28 1/2"

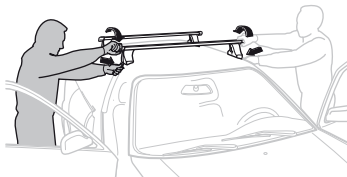
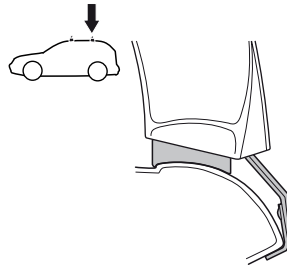
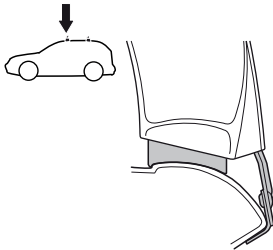
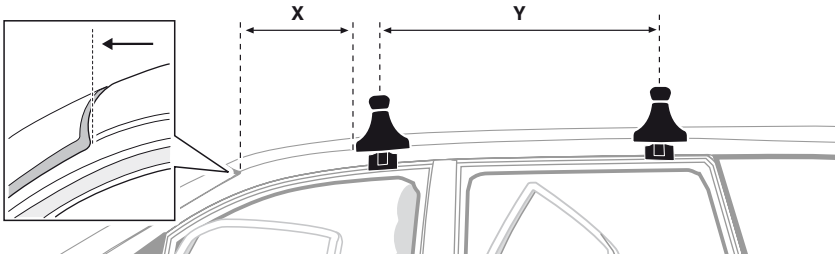

**GB/US** Tighten alternately

**D** Die Schrauben abwechselnd anziehen

**F** Serrer alternativement chaque côté

**NL** Afwisselend aan de linker- en de rechterkant aandraaien

**I** Alternare il serraggio delle viti

**E** Apertar alternativamente

**PT** Aperte alternadamente

**S** Dra åt växelvis

**FIN** Kierrä vuorotellen

**EST** Pinguldage vaheldumisi

**LAT** Pielieciet pamišus

**LIT** Užsukinėkite pakaitomis

**PL** Śruby dokręcaj naprzemiennie

**RU** Затягивайте попеременно

**CZ** Pokręťta bagażníka dokręcaj dokręcaj naprzemiennie.

**SK** Doťahujte striedavo

**SLO** Privijajte izmenično.

**HR** Naizmjenično zategnite

**HU** Egymástól függetlenül szorítandó

**GR** Σφιγγετε εναλλάξ

**TR** Dönüşümlü sıkın

**中文** 交替拧紧

**한국어** 번갈아 가며 조이십시오.

**日本語** 交互に締め付けてください。

**ไทย** ชันโนแบบสลับ

6



480R/754



480

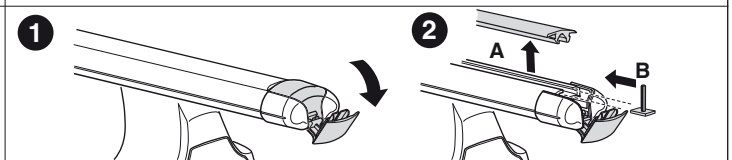
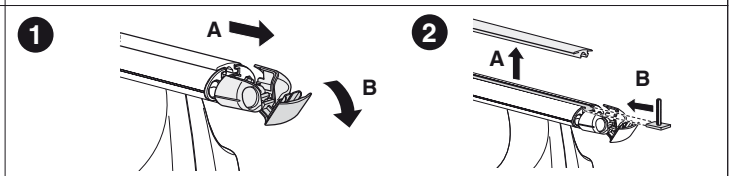
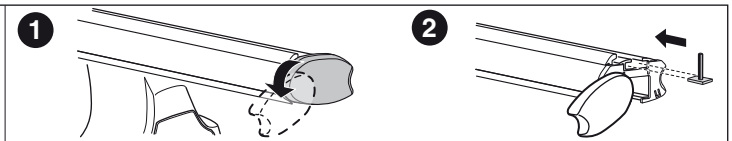
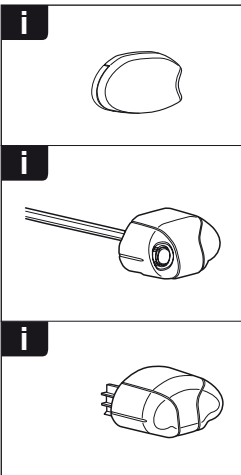
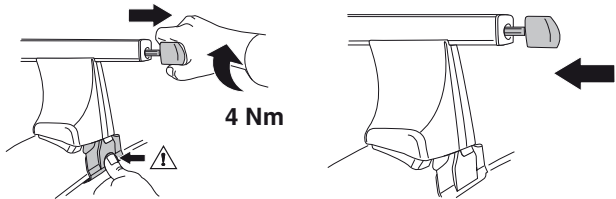
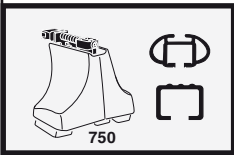
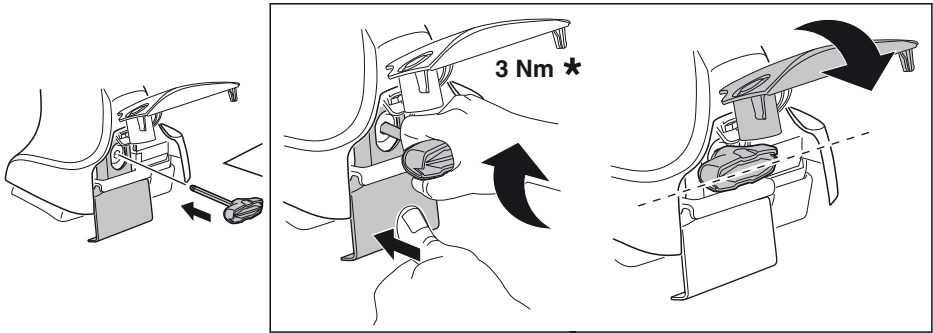

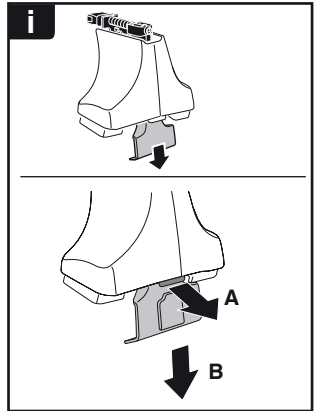
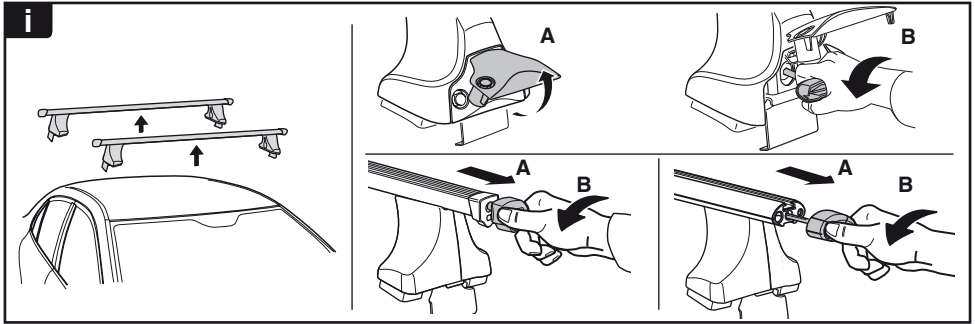

**THULE**  
SWEDEN  
**ONE  
KEY  
SYSTEM**



<b>544</b>		(x4)
<b>596</b>		(x6)
<b>588</b>		(x8)
NA <b>510</b>		(x10)
EUR		
ASIA <b>452</b>		(x12)



WW ▶ Thule Sweden AB, Box 69, 330 33 Hillerstorp, SWEDEN  
NA ▶ Thule Inc., 42 Silvermine Road, Seymour, Connecticut 06483, USA

info@thule.com  
customer.service@thule.com

www.thule.com