

# Kit 1566

TOYOTA Prius, 5-dr Hatchback, 09–

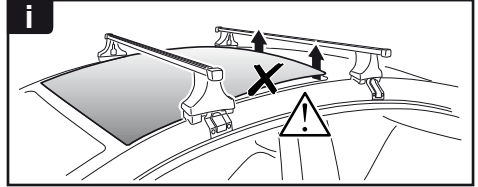

480R  
754

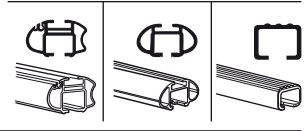
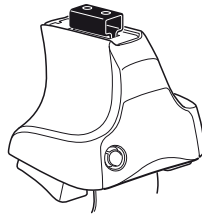

480

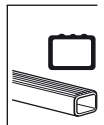
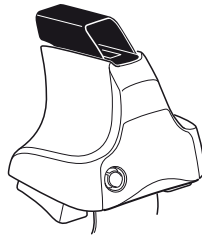

750

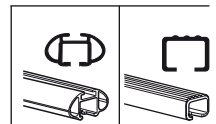
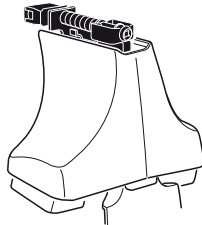

**THULE**<sup>®</sup>  
SWEDEN

ISO 11154-E

**Kit**



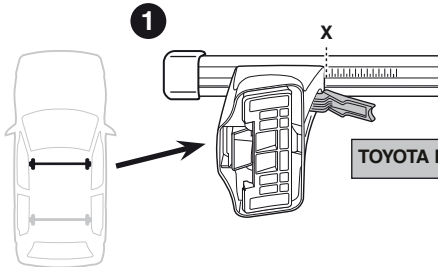

<b>1</b>	<b>2</b>	<b>X</b>
TOYOTA Prius, 5-dr Hatchback, 09–		<b>39</b>

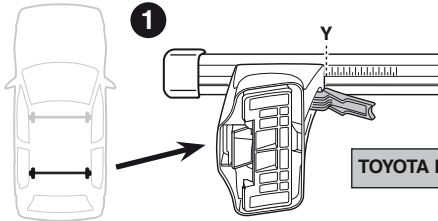

<b>1</b>	<b>2</b>	<b>Y</b>
TOYOTA Prius, 5-dr Hatchback, 09–		<b>35,5</b>

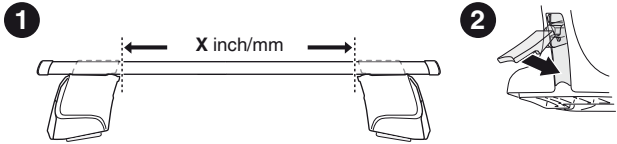
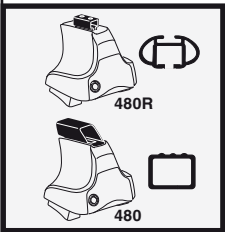

<b>1</b>	<b>2</b>	<b>X inch</b>	<b>X mm</b>
TOYOTA Prius, 5-dr Hatchback, 09–		<b>41"</b>	<b>1041 mm</b>

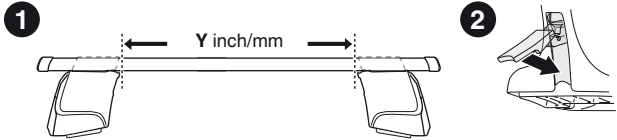
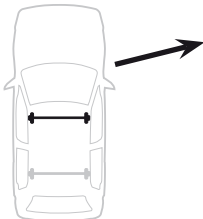

<b>1</b>	<b>2</b>	<b>Y inch</b>	<b>Y mm</b>
TOYOTA Prius, 5-dr Hatchback, 09–		<b>39 5/8"</b>	<b>1006 mm</b>

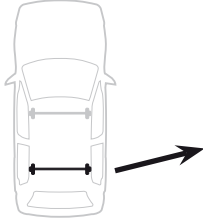

# 4

TOYOTA Prius, 5-dr Hatchback, 09-

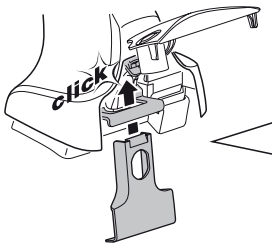
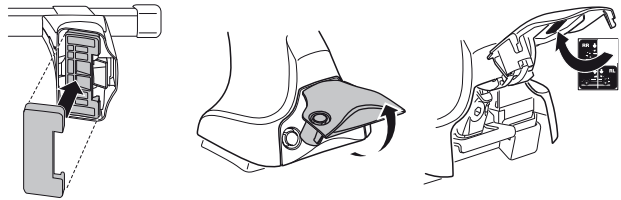
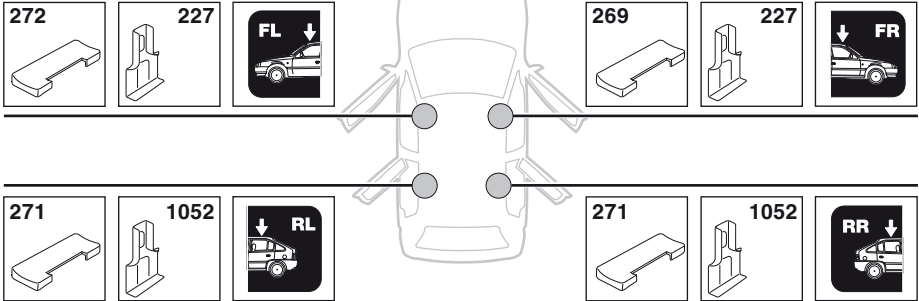

5



	X mm	Y mm	X inch	Y inch
TOYOTA Prius, 5-dr Hatchback, 09–	310 mm	700 mm	12 1/4"	27 1/2"

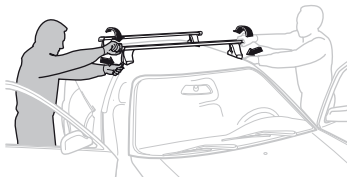
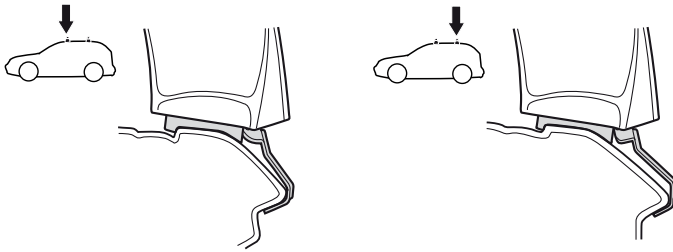
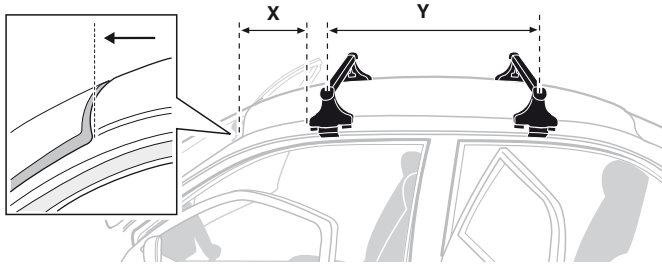

**GB/US** Tighten alternately

**D** Die Schrauben abwechselnd anziehen

**F** Serrer alternativement chaque côté

**NL** Afwisselend aan de linker- en de rechterkant aandraaien

**I** Alternare il serraggio delle viti

**E** Apertar alternativamente

**PT** Aperte alternadamente

**S** Dra åt växelvis

**FIN** Kierrä vuorotellen

**EST** Pinguldage vaheldumisi

**LAT** Pielieciet pamišus

**LIT** Užsukinėkite pakaitomis

**PL** Śruby dokręcaj naprzemiennie

**RU** Затягивайте попеременно

**CZ** Pokręťta багаžníka dokręcaj dokręcaj naprzemiennie.

**SK** Doťahujte striedavo

**SLO** Privijajte izmenično.

**HR** Naizmjenično zategnite

**HU** Egymástól függetlenül szorítandó

**GR** Σφιγγετε εναλλάξ

**TR** Dönüşümlü sıkın

**中文** 交替拧紧

**한국어** 번갈아 가며 조이십시오.

**日本語** 交互に締め付けてください。

**ไทย** ชั้้นโน้แบบสลับ

6



480R/754



480

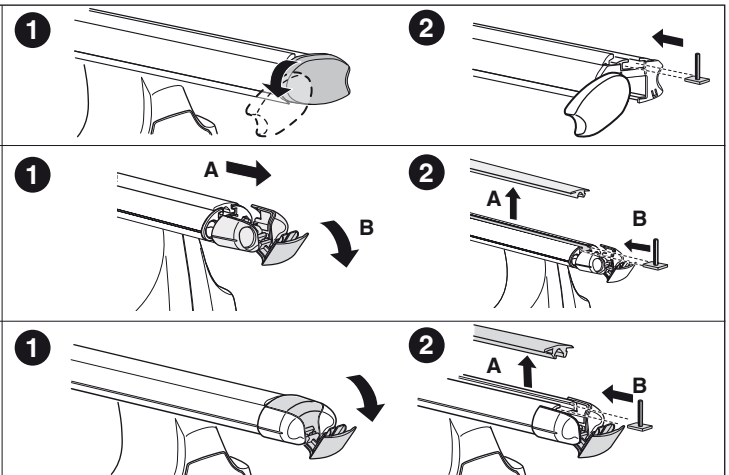
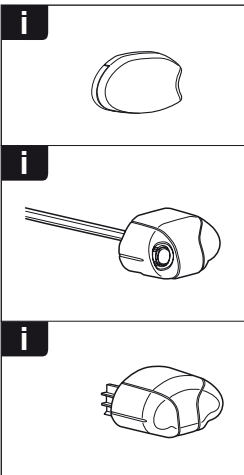
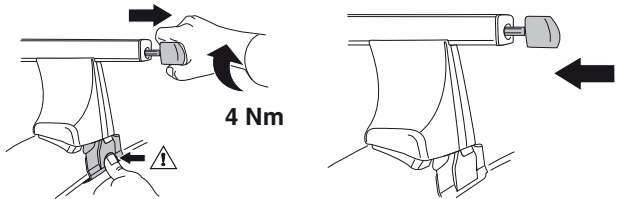
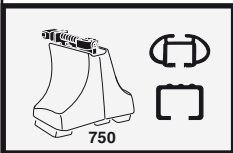
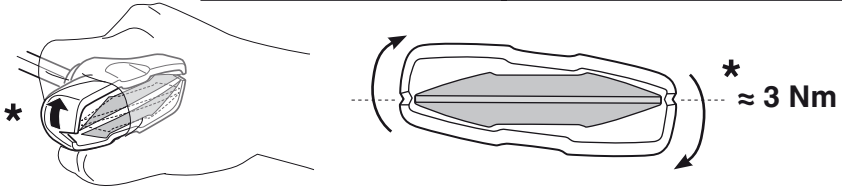
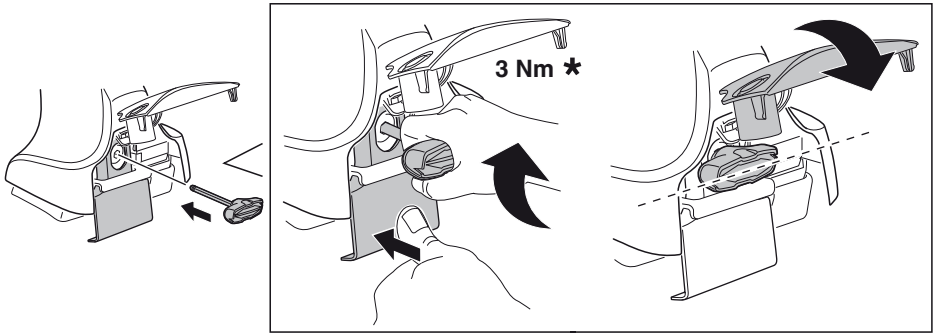

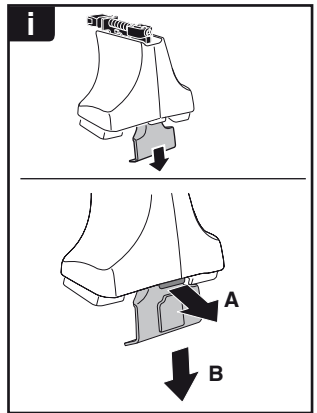
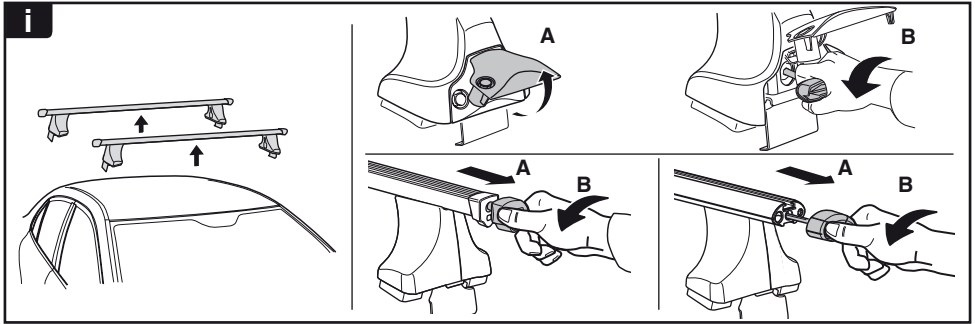

**THULE**  
SWEDEN  
**ONE  
KEY  
SYSTEM**



- 544 (x4)
- 596 (x6)
- 588 (x8)
- NA 510 (x10)
- EUR 452 (x12)
- ASIA

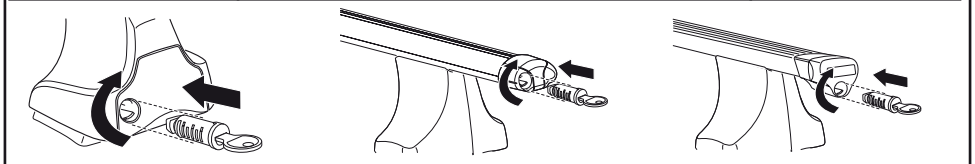

WW ▶ Thule Sweden AB, Box 69, 330 33 Hillerstorp, SWEDEN  
NA ▶ Thule Inc., 42 Silvermine Road, Seymour, Connecticut 06483, USA

info@thule.com  
customer.service@thule.com

www.thule.com