

Kit 1597

VOLKSWAGEN Jetta, 4-dr Sedan, 05-

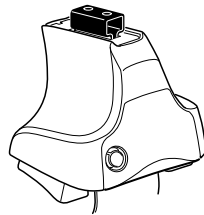

480R
754

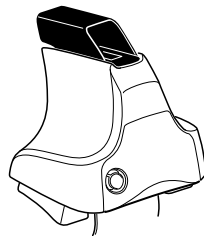
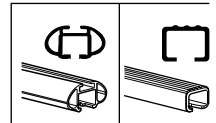

480

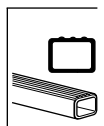

Kit

1

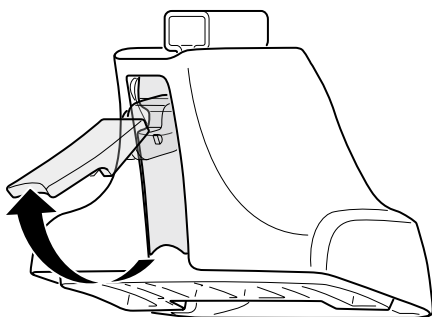
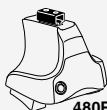

2

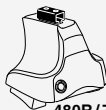

+

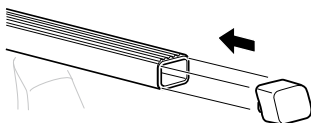
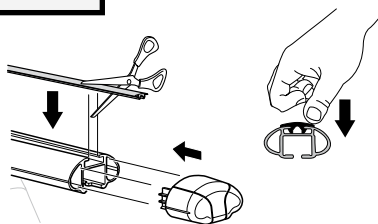
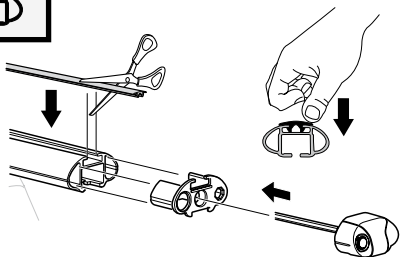
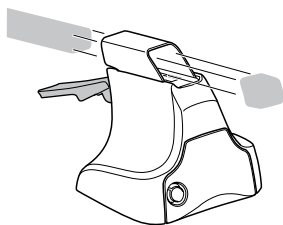
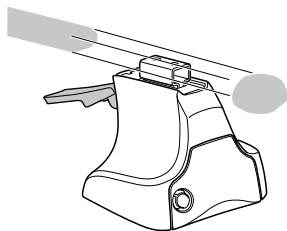

3

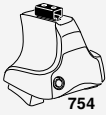

754

1

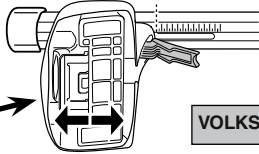
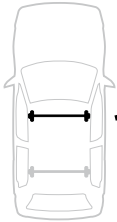

2

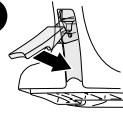

VOLKSWAGEN Jetta, 4-dr Sedan, 05-

X

38,5

1

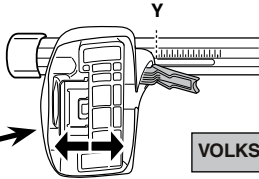

2

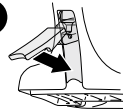

VOLKSWAGEN Jetta, 4-dr Sedan, 05-

Y

35



480R



480



1

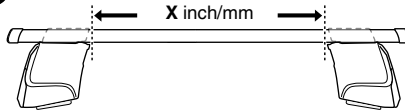

2

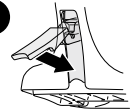

VOLKSWAGEN Jetta, 4-dr Sedan, 05-

X inch

X mm

40 3/4"

1036 mm

1

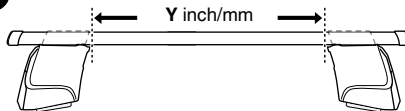

2

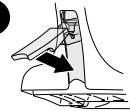

VOLKSWAGEN Jetta, 4-dr Sedan, 05-

Y inch

Y mm

39 3/8"

1001 mm

4



480R/754



480

VOLKSWAGEN Jetta, 4-dr Sedan, 05-

164



1087



163



1087



137



714



137



714

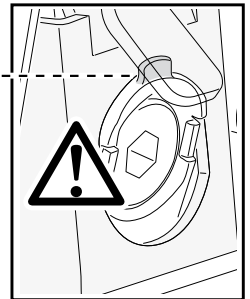
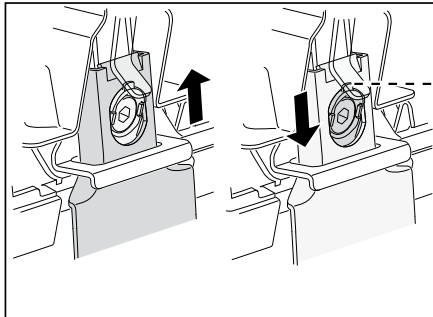
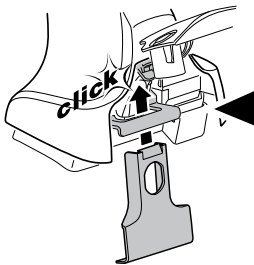
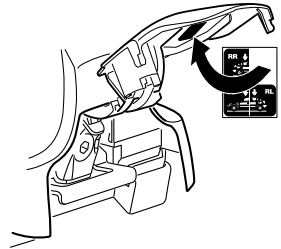
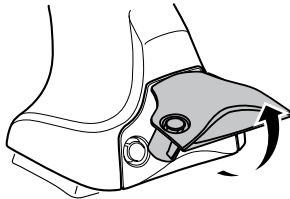
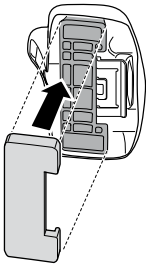

5

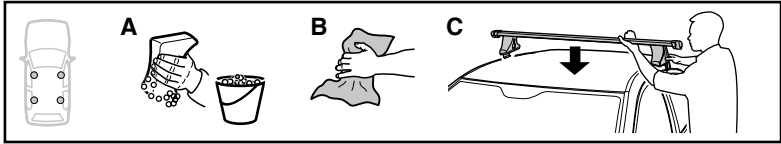

	X mm	Y mm	X inch	Y inch
VOLKSWAGEN Jetta, 4-dr Sedan, 05-	320 mm	725 mm	12 5/8 "	28 1/4 "

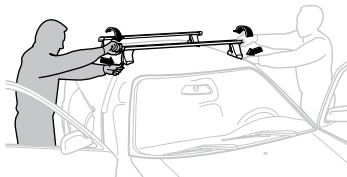
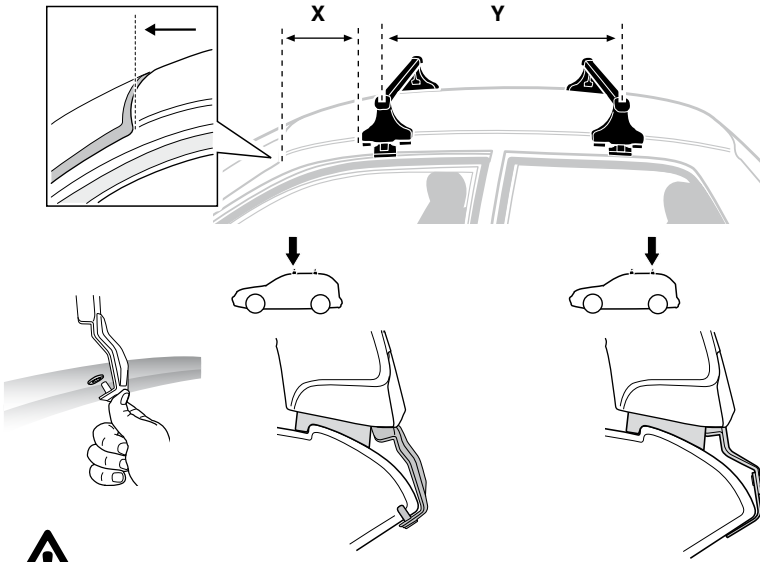

GB/US Tighten alternately

D Die Schrauben abwechselnd anziehen

F Serrer alternativement chaque côté

NL Afwisselend aan de linker- en de rechterkant aandraaien

I Alternare il serraggio delle viti

E Serrare alternativamente

PT Aperte alternadamente

S Dra åt växelvis

FIN Kierrä vuorotellen

EST Pinguldage vaheldumisi

LAT Pielieciet pamišus

LIT Užsukinėkite pakaitomis

PL Śruby dokręcaj naprzemiennie

RU Затягивайте попеременно

CZ Pokręťta bagażníka dokręcaj dokręcaj naprzemiennie.

SK Doťahujte striedavo

SLO Privijajte izmenično.

HR Naizmjenično zategnite

HU Egymástól függetlenül szorítandó

GR Σφιγγετε εναλλάξ

TR Dönüşümlü sıkın

中文 交替拧紧

한국어 번갈아 가며 조이십시오.

日本語 交互に締め付けてください。

ไทย ชับโน้นแบบสลับ

6

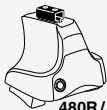

480R/754



480

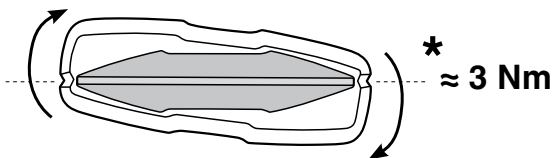
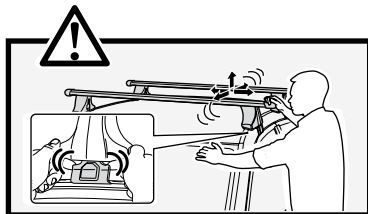
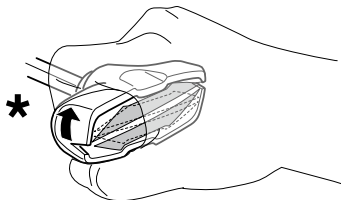
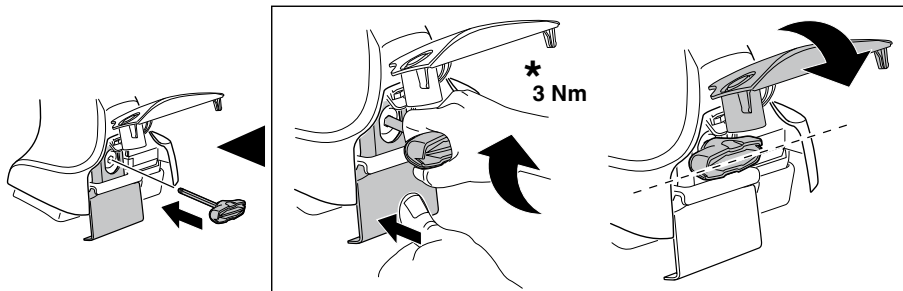

7

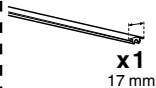

x1
17 mm

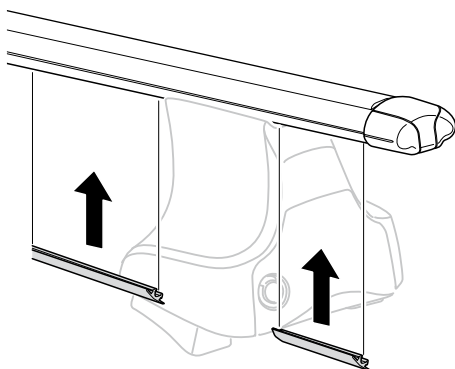

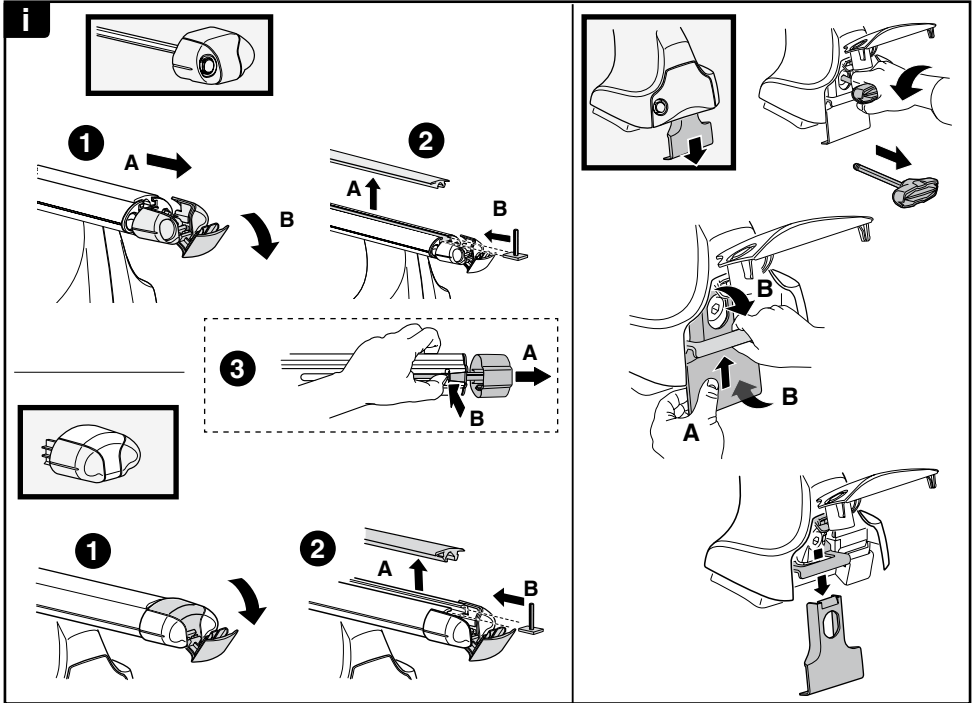
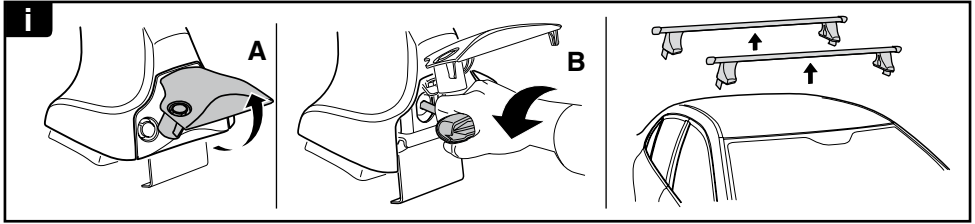

THULE
SWEDEN
**ONE
KEY
SYSTEM**

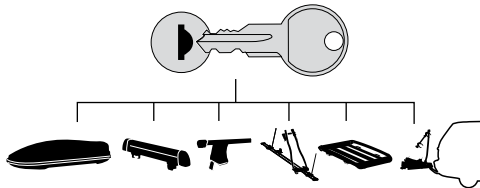

544 (x4)

596 (x6)

588 (x8)

NA **510** (x10)

EUR **452** (x12)

ASIA

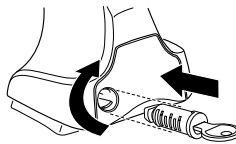

WW ▶ Thule Sweden AB, Box 69, 330 33 Hillerstorp, SWEDEN
NA ▶ Thule Inc., 42 Silvermine Road, Seymour, Connecticut 06483, USA

info@thule.com
customer.service@thule.com

www.thule.com