

# Kit 1606

VOLKSWAGEN Polo (Mk.V), 3-dr Hatchback, 10-

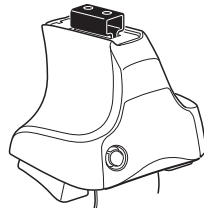

480R Rapid Traverse  
754 Rapid System

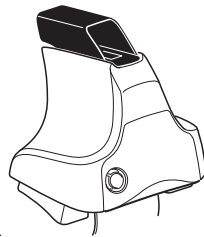
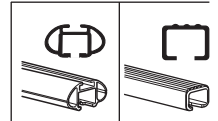

480 Traverse

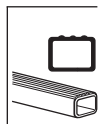

**Kit**

1



480R Rapid Traverse  
754 Rapid System



480 Traverse

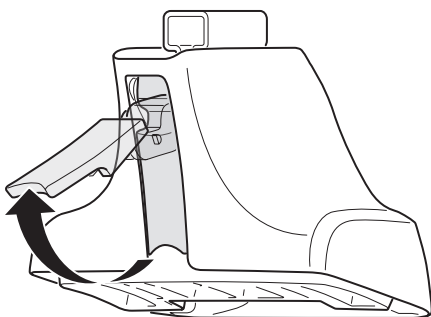

2

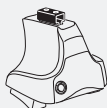

480R Rapid Traverse  
754 Rapid System



480 Traverse

+

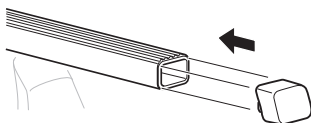
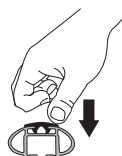
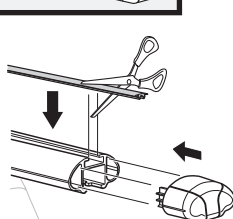
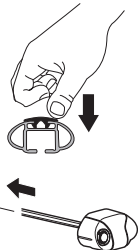
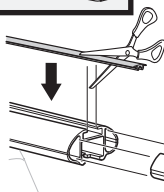
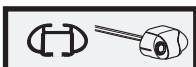
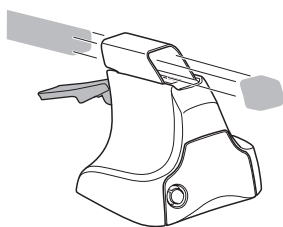
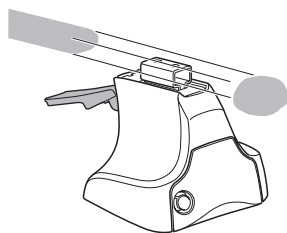

**3**

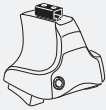

754 Rapid System

**1**

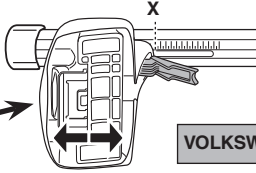
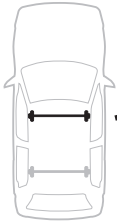

**2**

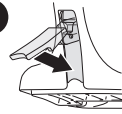

	X
VOLKSWAGEN Polo (Mk.V), 3-dr Hatchback, 10-	37

**1**

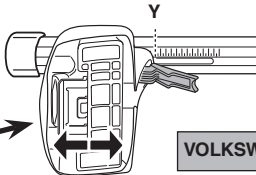

**2**

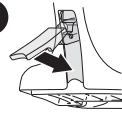

	Y
VOLKSWAGEN Polo (Mk.V), 3-dr Hatchback, 10-	33



480R Rapid Traverse



480 Traverse

**1**

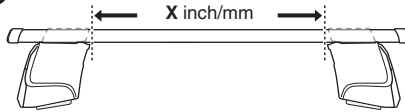

**2**

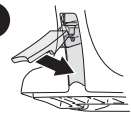

	X inch	X mm
VOLKSWAGEN Polo (Mk.V), 3-dr Hatchback, 10-	40 1/4"	1021 mm

**1**

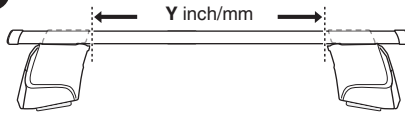

**2**

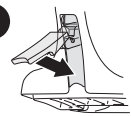

	Y inch	Y mm
VOLKSWAGEN Polo (Mk.V), 3-dr Hatchback, 10-	38 5/8"	981 mm

4

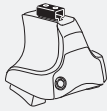

480R Rapid Traverse  
754 Rapid System



480 Traverse

VOLKSWAGEN Polo (Mk.V), 3-dr Hatchback, 10-

331

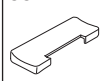

1088



332

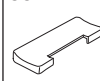

1089

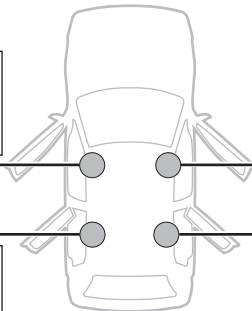
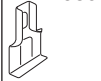

328

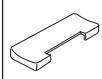

349

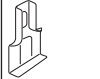

328

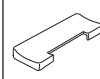

349

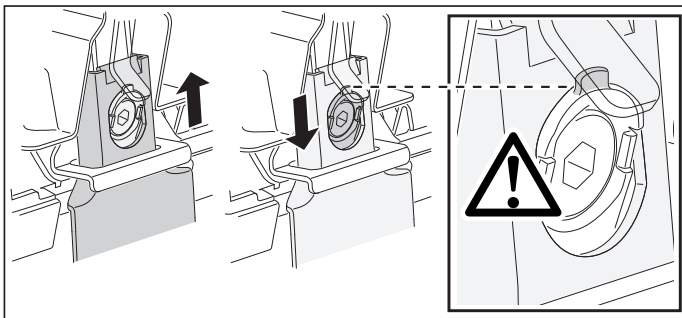
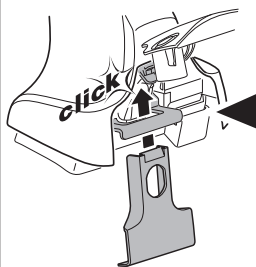
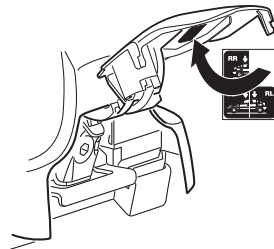
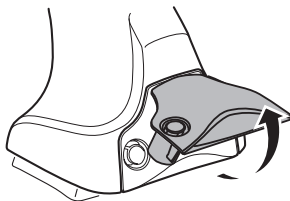
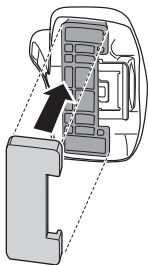
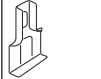

5

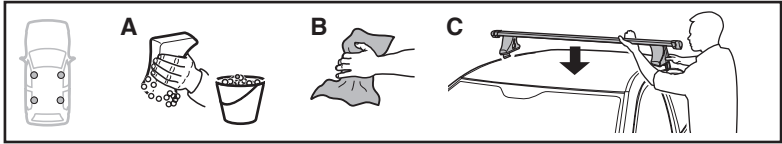

	X mm	Y mm	X inch	Y inch
VOLKSWAGEN Polo (Mk.V), 3-dr Hatchback, 10-	200 mm	730 mm	7 7/8"	26 3/4"

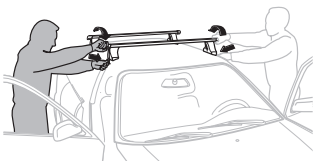
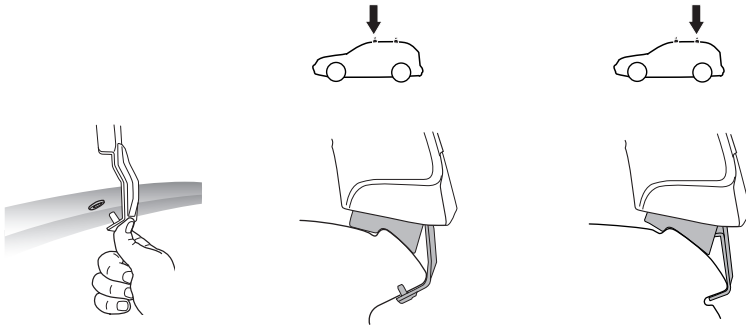
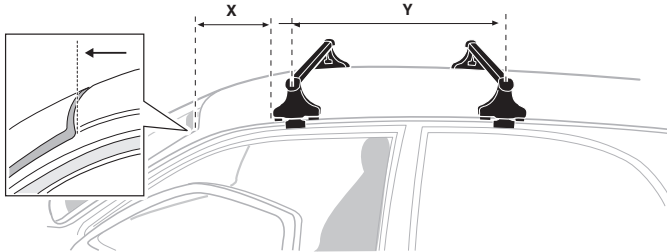

- |              |   |            |   |
|--------------|---|------------|---|
| <b>GB/US</b> | Tighten alternately                                     | <b>CZ</b>  | Pokreťta bagazníka dokrećaj dokrećaj naprzemiennie. |
| <b>D</b>     | Die Schrauben abwechselnd anziehen                      | <b>SK</b>  | Dofahujte striedavo                                 |
| <b>F</b>     | Serrer alternativement chaque côté                      | <b>SLO</b> | Privijajte izmenično.                               |
| <b>NL</b>    | Afwisselend aan de linker- en de rechterkant aandraaien | <b>HR</b>  | Naizmjenoćno zategnite                              |
| <b>I</b>     | Alternare il serraggio delle viti                       | <b>HU</b>  | Egymástól függetlenül szorítandó                    |
| <b>E</b>     | Apretar alternativamente                                | <b>GR</b>  | Σφιγγετε εναλλάξ                                    |
| <b>PT</b>    | Aperte alternadamente                                   | <b>TR</b>  | Dönüşümlü sıkın                                     |
| <b>S</b>     | Dra åt växelvis   | <b>中文</b>  | 交替拧紧  |
| <b>FIN</b>   | Kierrä vuorotellen                                      | <b>한국어</b> | 번갈아 가며 조이십시오.                                       |
| <b>EST</b>   | Pinguldage vaheldumisi                                  | <b>日本語</b> | 交互に締め付けてください。                                       |
| <b>LAT</b>   | Pievēciēt pamīšus                                       | <b>ไทย</b> | ขันในแบบสลับ  |
| <b>LIT</b>   | Užsukinėkite pakaitomis                                 |            |   |
| <b>PL</b>    | Śruby dokrećaj naprzemiennie                            |            |   |
| <b>RU</b>    | Затягивайте попеременно                                 |            |   |

6

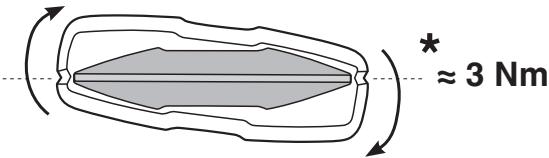
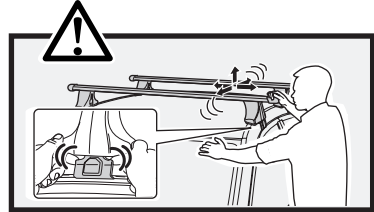
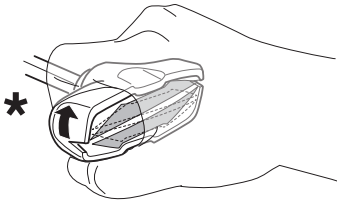
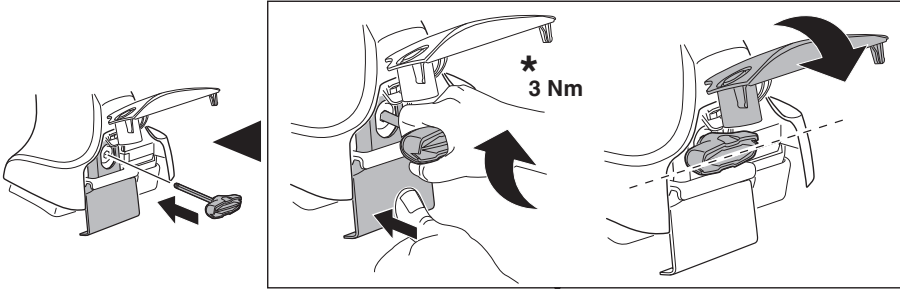
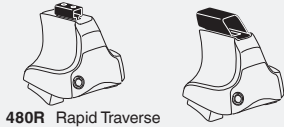

7

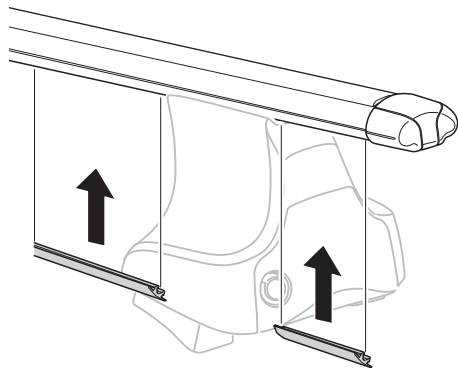
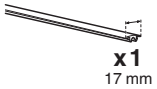

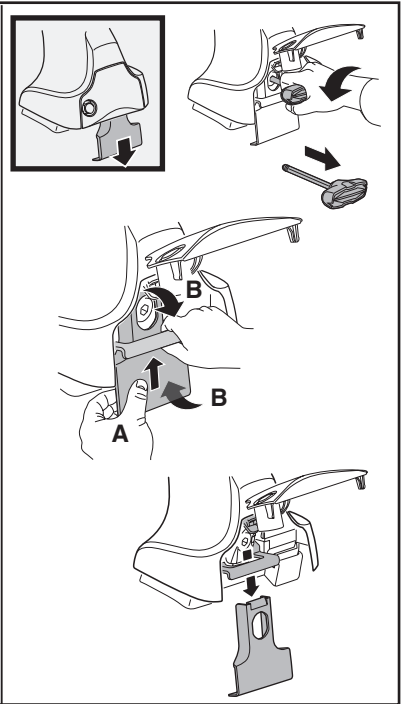
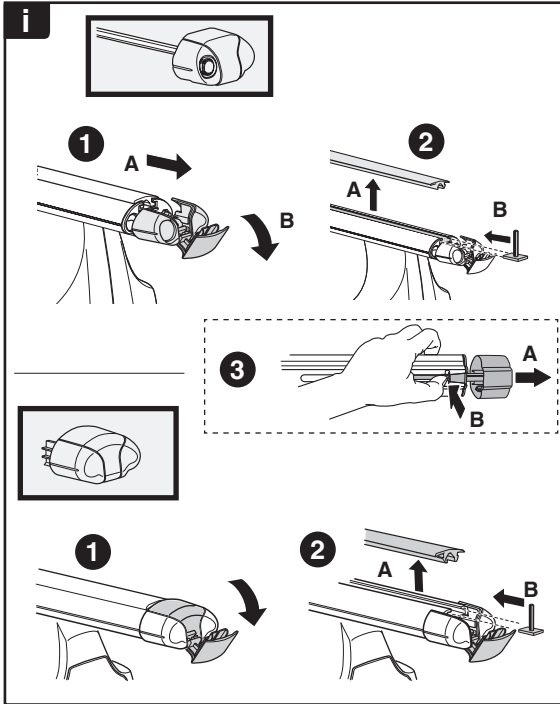
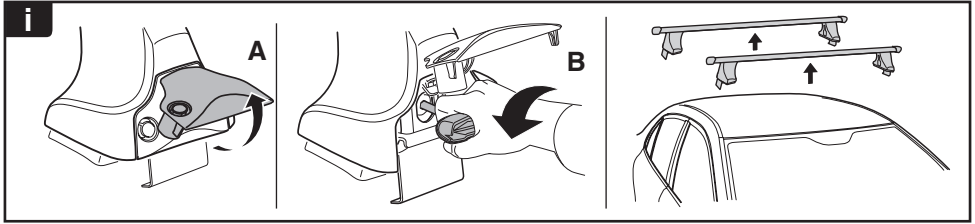

**THULE**  
SWEDEN  
**ONE  
KEY  
SYSTEM**

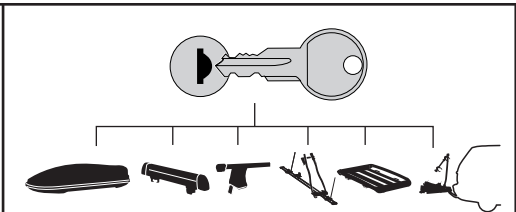

		(x4)
		(x6)
		(x8)
NA		(x10)
EUR		(x12)
ASIA		(x12)

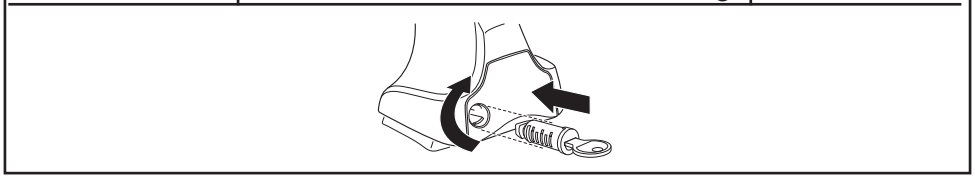

WW ▶ Thule Sweden AB, Box 69, 330 33 Hillerstorp, SWEDEN  
NA ▶ Thule Inc., 42 Silvermine Road, Seymour, Connecticut 06483, USA

info@thule.com  
customer.service@thule.com

www.thule.com