

# Kit 1630

TOYOTA Corolla, 4-dr Sedan, 02-06 / \*03-08

TOYOTA Corolla Altis, 4-dr Sedan, 01-06

\*North America

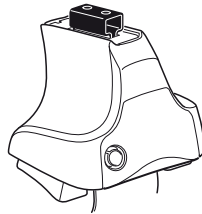

754 Rapid System  
480R Rapid Traverse (North America)

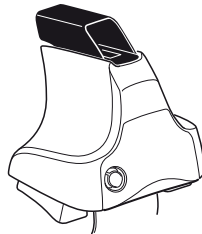
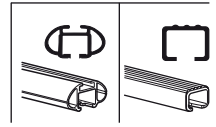

480 Traverse (North America)

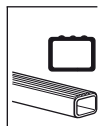



1

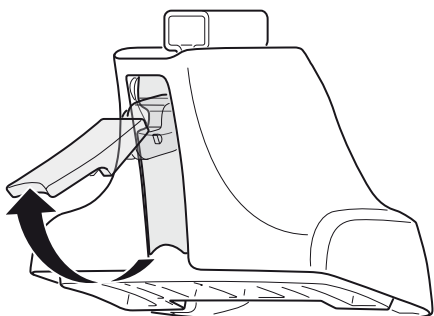

2



754 Rapid System  
480R Rapid Traverse  
(North America)

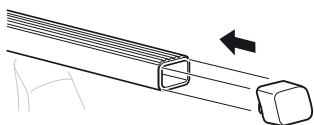
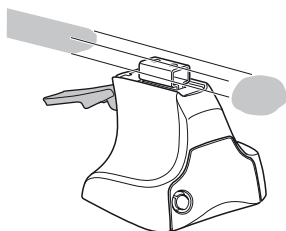

x4

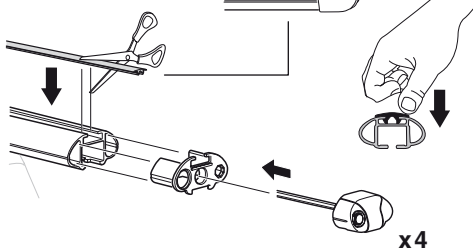
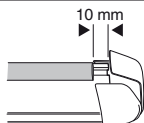

x4

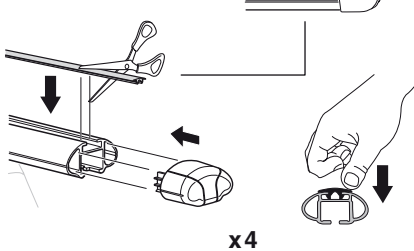
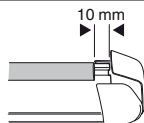

x4



480 Traverse  
(North America)

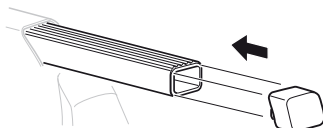
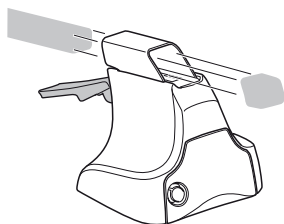

x4

**3**

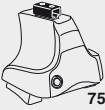

**754** Rapid System

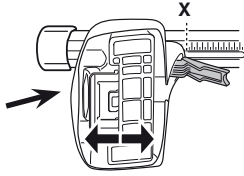

	<b>X</b>
<b>TOYOTA Corolla, 4-dr Sedan, 02-06 / *03-08</b>	<b>30,5</b>
<b>TOYOTA Corolla Altis, 4-dr Sedan, 01-06</b>	<b>30,5</b>

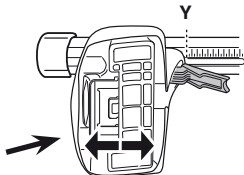

	<b>Y</b>
<b>TOYOTA Corolla, 4-dr Sedan, 02-06 / *03-08</b>	<b>32,5</b>
<b>TOYOTA Corolla Altis, 4-dr Sedan, 01-06</b>	<b>32,5</b>

**3**



**480R** Rapid Traverse



**480** Traverse

**(North America)**



	<b>X inch</b>	<b>X mm</b>
<b>TOYOTA Corolla, 4-dr Sedan, 02-06 / *03-08</b>	<b>37 <sup>5</sup>/<sub>8</sub> "</b>	<b>956 mm</b>
<b>TOYOTA Corolla Altis, 4-dr Sedan, 01-06</b>	<b>37 <sup>5</sup>/<sub>8</sub> "</b>	<b>956 mm</b>



	<b>Y inch</b>	<b>Y mm</b>
<b>TOYOTA Corolla, 4-dr Sedan, 02-06 / *03-08</b>	<b>38 <sup>3</sup>/<sub>8</sub> "</b>	<b>976 mm</b>
<b>TOYOTA Corolla Altis, 4-dr Sedan, 01-06</b>	<b>38 <sup>3</sup>/<sub>8</sub> "</b>	<b>976 mm</b>

**4**

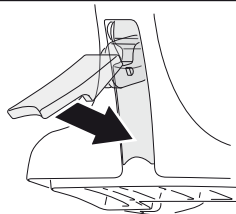

# 5

TOYOTA Corolla, 4-dr Sedan, 02-06 / \*03-08

TOYOTA Corolla Altis, 4-dr Sedan, 01-06

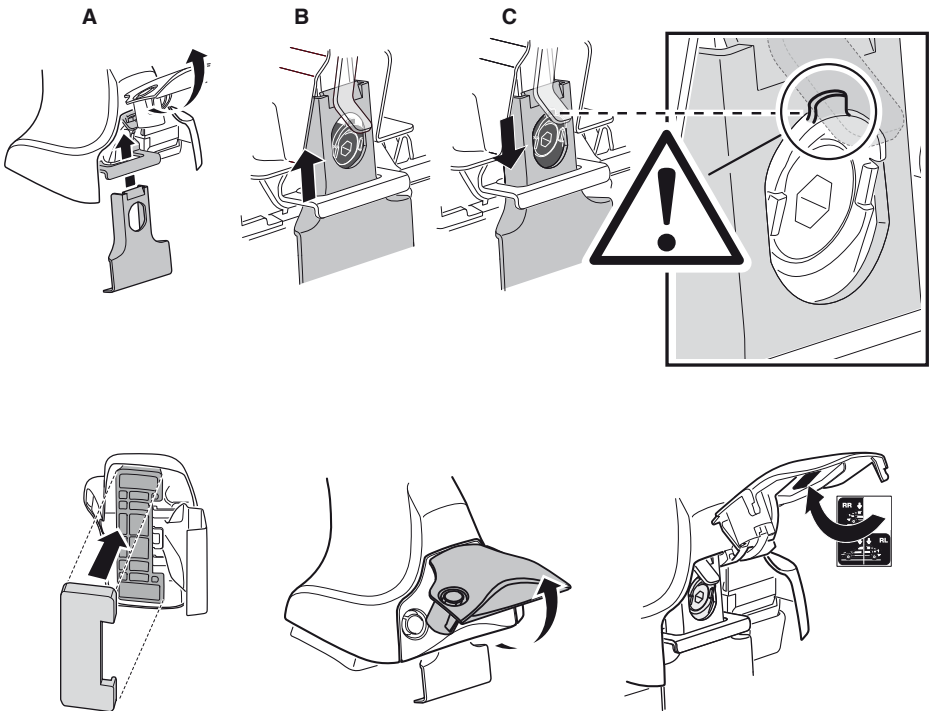
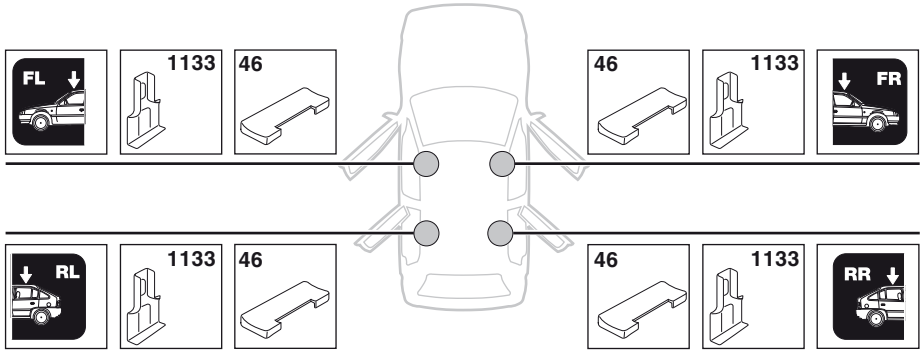

6

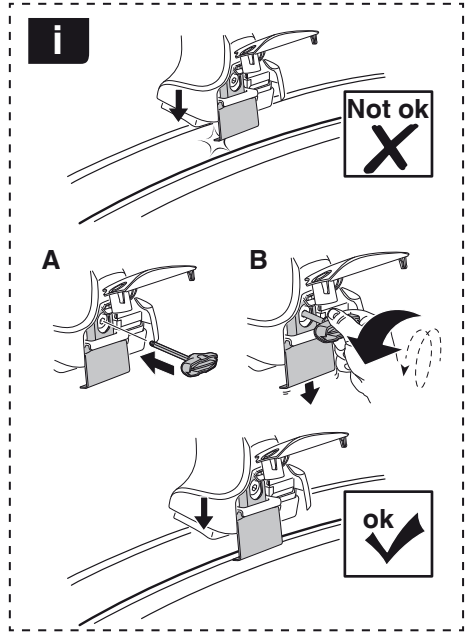
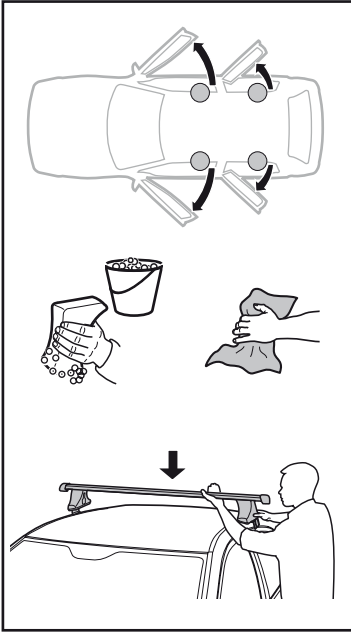

	X mm	Y mm	X inch	Y inch
TOYOTA Corolla, 4-dr Sedan, 02-06 / *03-08	250 mm	600 mm	9 7/8"	23 5/8"
TOYOTA Corolla Altis, 4-dr Sedan, 01-06	250 mm	600 mm	9 7/8"	23 5/8"

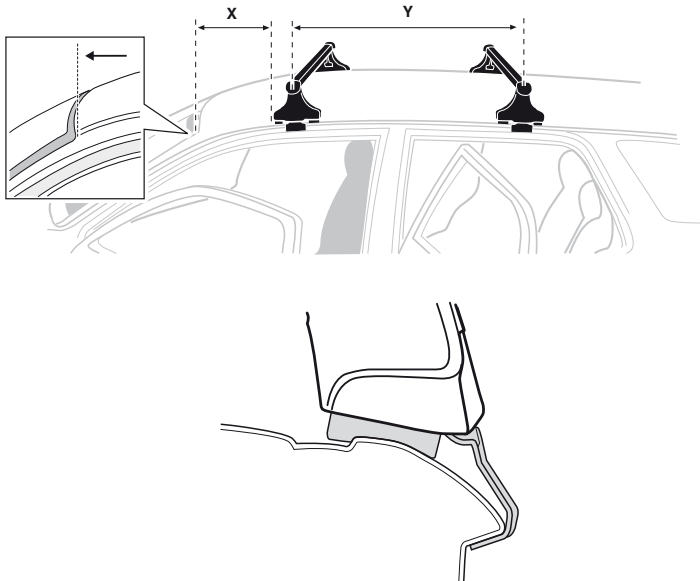

7

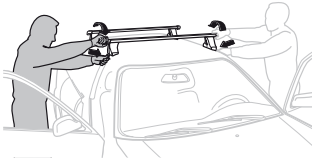

<b>GB/US</b>	Tighten alternately
<b>D</b>	Die Schrauben abwechselnd anziehen
<b>F</b>	Serrer alternativement chaque côté
<b>NL</b>	Afwisselend aan de linker- en de rechterkant aandraaien
<b>I</b>	Alternare il serraggio delle viti
<b>E</b>	Apertar alternativamente
<b>PT</b>	Aperte alternadamente
<b>S</b>	Dra åt växelvis
<b>FIN</b>	Kierrä vuorotellen
<b>EST</b>	Pinguldage vaheldumisi
<b>LAT</b>	Pielveiciet pamišus
<b>LIT</b>	Užsukinėkite pakaitomis
<b>PL</b>	Śruby dokręcaj naprzemiennie
<b>RU</b>	Затягивайте попеременно

<b>CZ</b>	Pokręťta bagażnika dokręcaj naprzemiennie.
<b>SK</b>	Dofahajte striedavo
<b>SLO</b>	Privijajte izmenično.
<b>HR</b>	Naizmjenočno zategnite
<b>HU</b>	Egymástól függetlenül szorítandó
<b>GR</b>	Σφιγίγες εναλλάξ
<b>TR</b>	Dönüşümlü sıkın

**中文** 交替拧紧

**한국어** 번갈아 가며 조이십시오.

**日本語** 交互に締め付けてください。

**ไทย** ชันในแบบสลับ

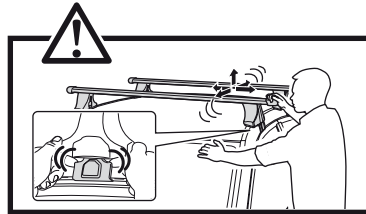
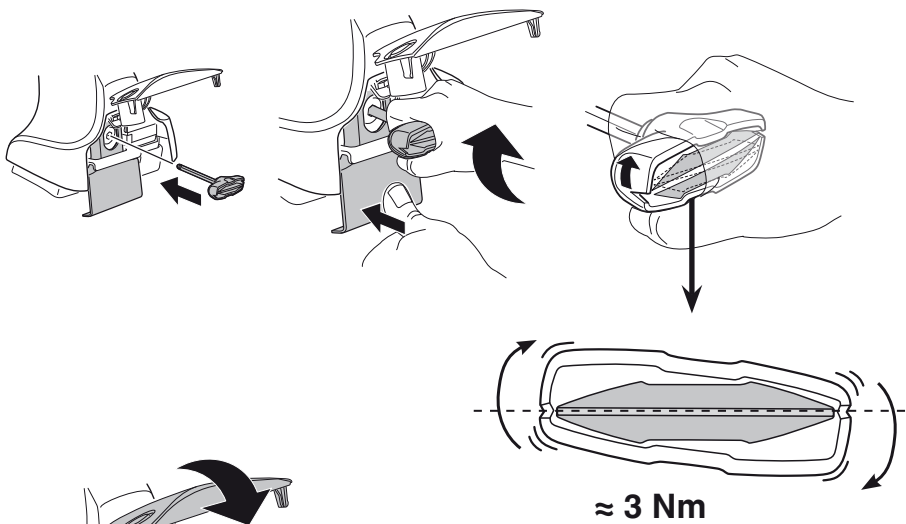

8

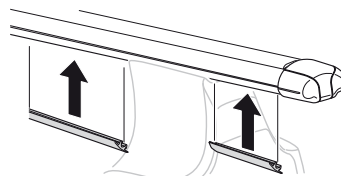
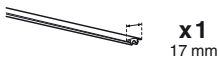

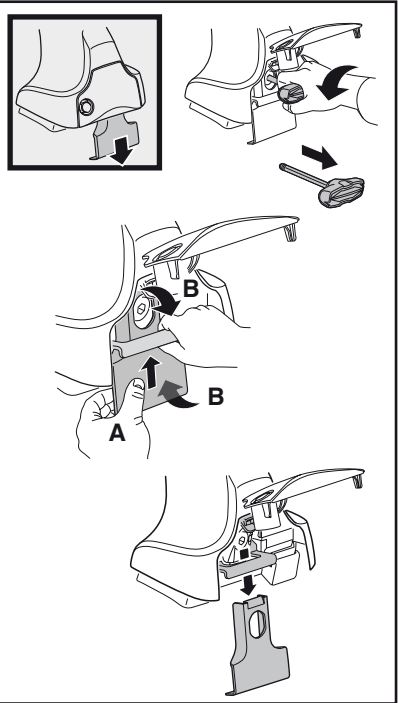
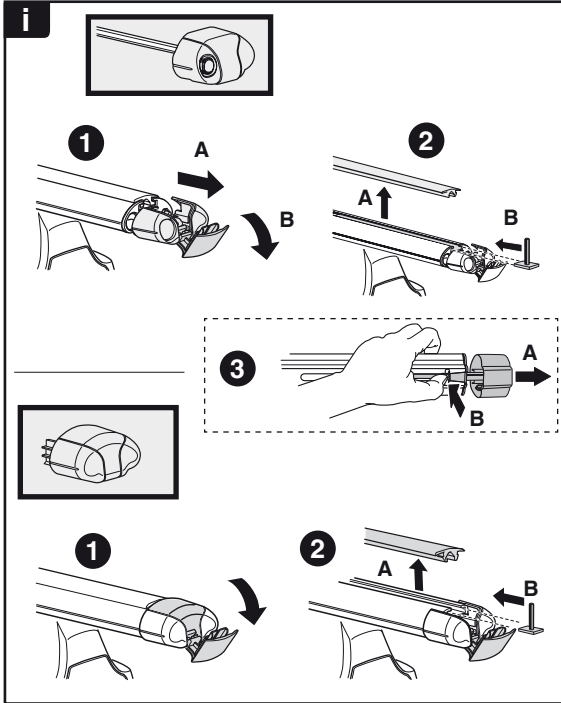
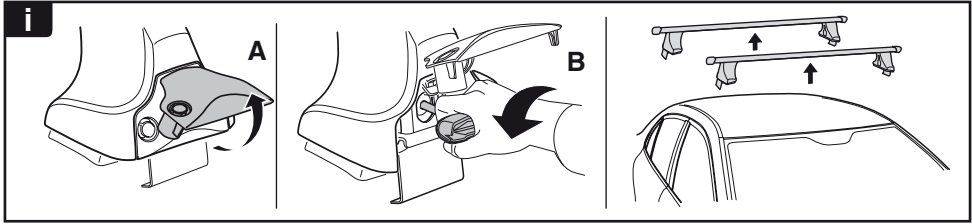

**THULE**  
SWEDEN  
**ONE  
KEY  
SYSTEM**

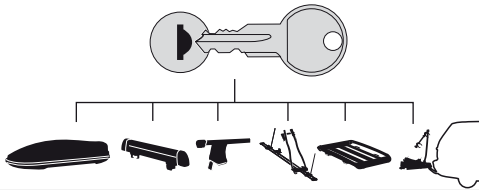

- 544** (x4)
- 596** (x6)
- 588** (x8)
- NA **510** (x10)
- EUR **452** (x12)
- ASIA

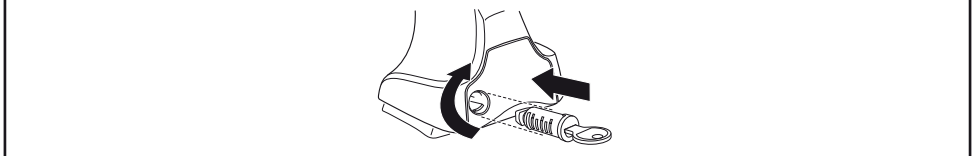

WW ▶ Thule Sweden AB, Box 69, 330 33 Hillerstorp, SWEDEN  
NA ▶ Thule Inc., 42 Silvermine Road, Seymour, Connecticut 06483, USA

info@thule.com  
customer.service@thule.com

www.thule.com