

Kit 1680

MINI Clubman, 4-dr Hatchback, 08–

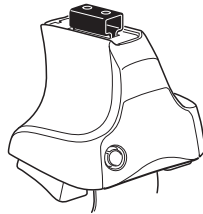

754 Rapid System
480R Rapid Traverse (North America)

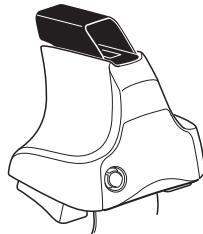
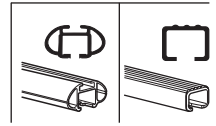

480 Traverse (North America)

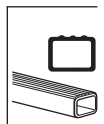

1

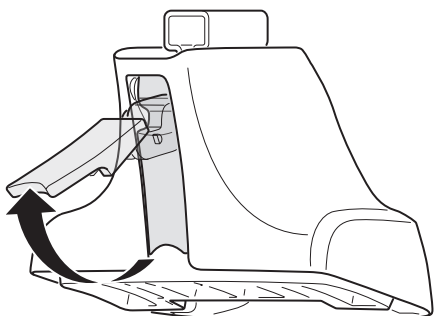

2



754 Rapid System
480R Rapid Traverse
(North America)

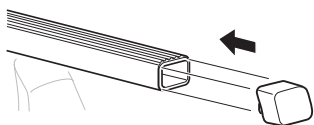
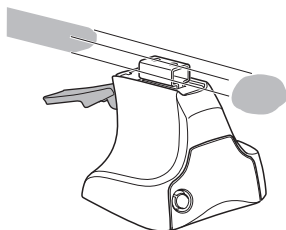

x4

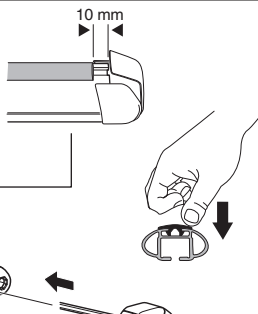

x4

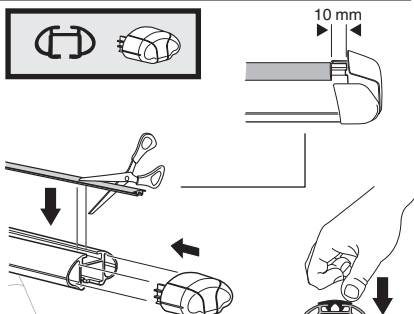

x4



480 Traverse
(North America)

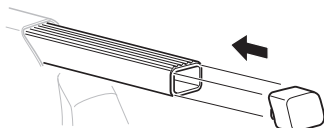
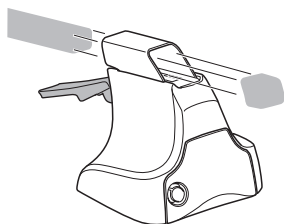

x4

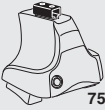
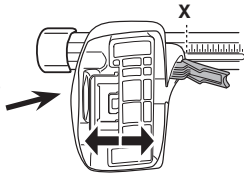
3**754** Rapid System

	X
MINI Clubman, 4-dr Hatchback, 08-	19,5

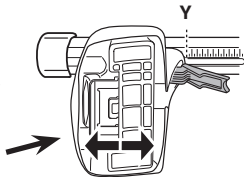

	Y
MINI Clubman, 4-dr Hatchback, 08-	19,5

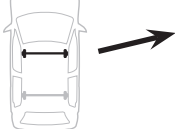
3**480R** Rapid Traverse**480** Traverse**(North America)**

	X inch	X mm
MINI Clubman, 4-dr Hatchback, 08-	33 1/4"	846 mm

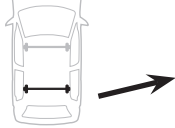

	Y inch	Y mm
MINI Clubman, 4-dr Hatchback, 08-	33 1/4"	846 mm

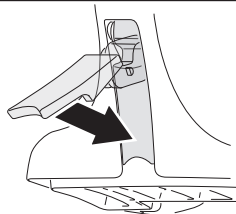
4

5

MINI Clubman, 4-dr Hatchback, 08-

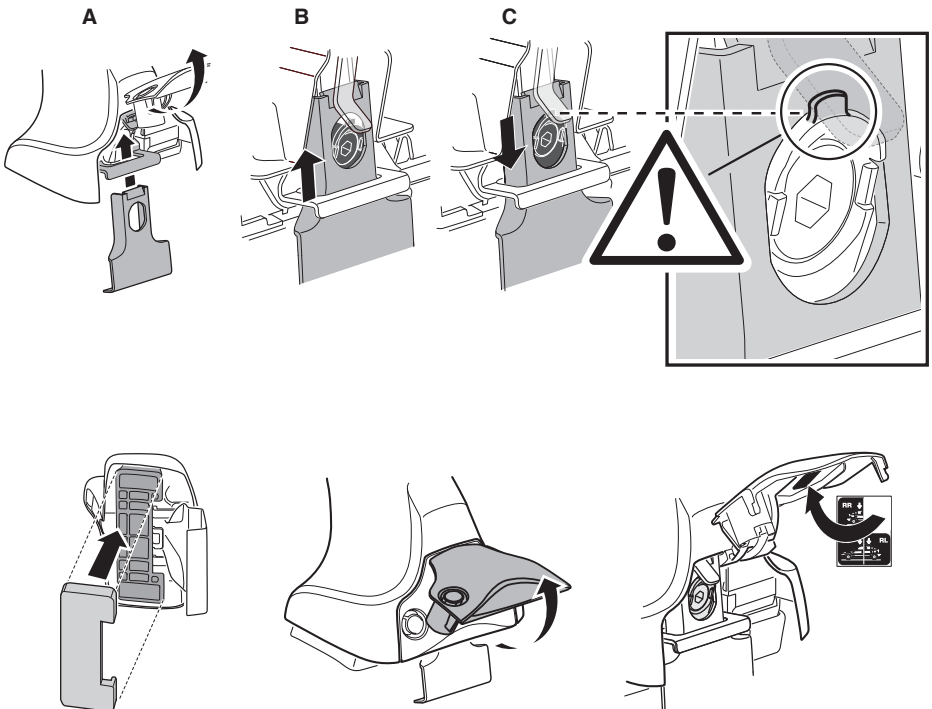
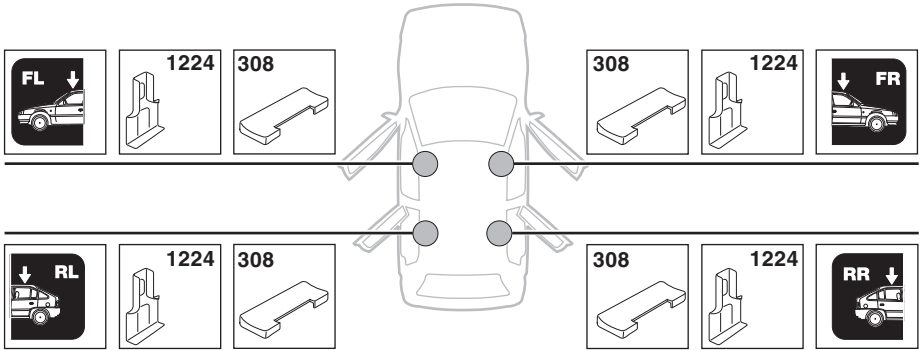

6

	X mm	Y mm	X inch	Y inch
MINI Clubman, 4-dr Hatchback, 08-	380 mm	750 mm	15"	29 1/2"

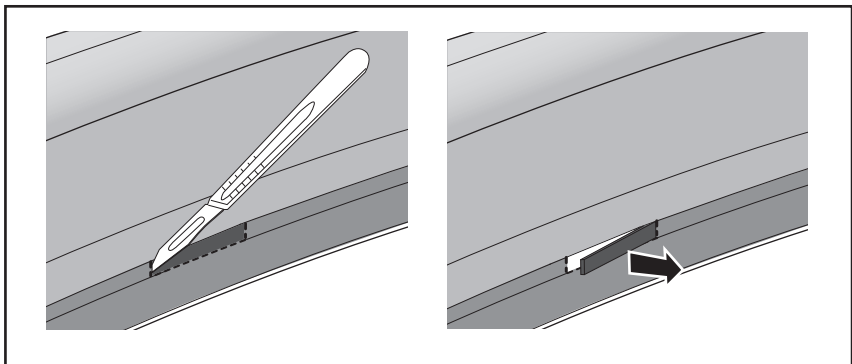
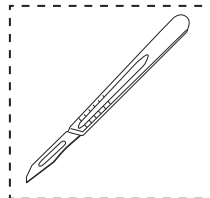
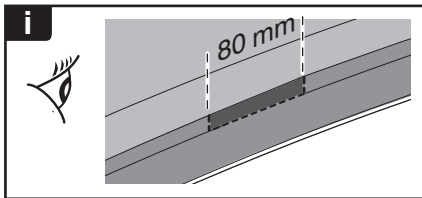
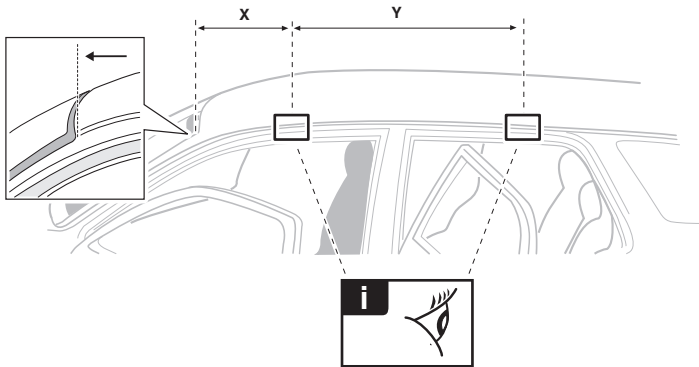

7

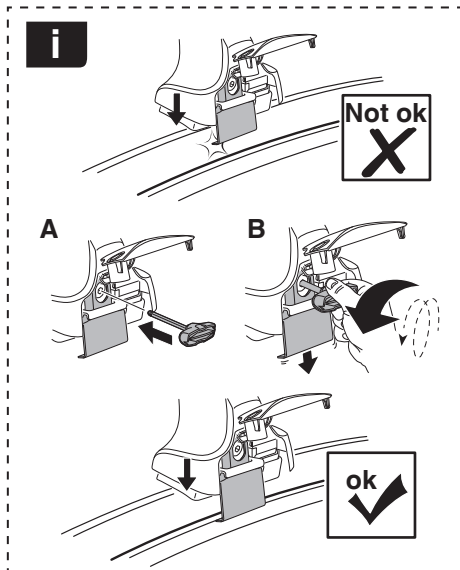
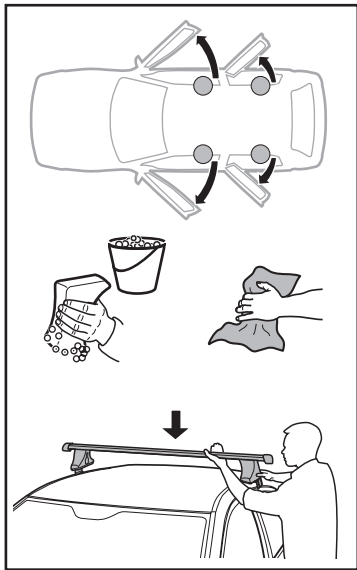

	X mm	Y mm	X inch	Y inch
MINI Clubman, 4-dr Hatchback, 08-	310 mm	750 mm	12 1/4"	29 1/2"

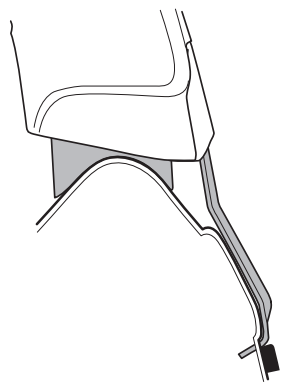
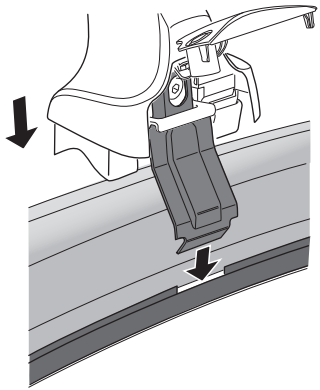
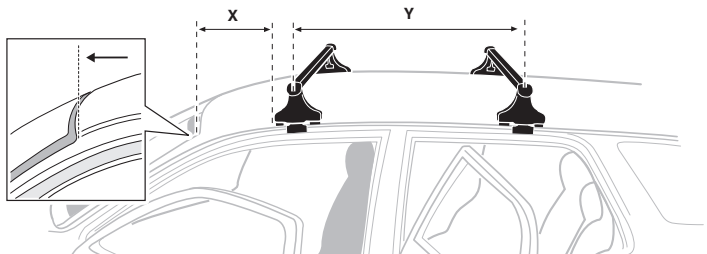

8

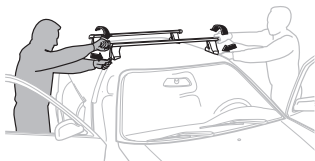

EN Tighten alternately
 DE Die Schrauben abwechselnd anziehen
 FR Serrer alternativement chaque côté
 NL Afwisselend aan de linker- en de rechterkant aandraaien
 IT Alternare il serraggio delle viti
 ES Apretar alternativamente
 PT Aperte alternadamente
 SV Dra åt växelvis
 DK Spænd skiftevis
 NE Trekk til vekselvis
 FI Kierrä vuorotellen
 ET Pinguldage vaheldumisi
 LV Pievelciēt pamišus
 LT Užsukinėkite pakaitomis
 PL Śruby dokręcaj naprzemiennie

RU Затягивайте попеременно
 UK Затягти по чергово
 BG Затегнете последователно
 CS Pokręťta багаžníka dokręcaj dokręcaj naprzemiennie.
 SK Dotiahujte striedavo
 SL Privijajte izmenično.
 HR/BIH Naizmjenično zategnite
 HU Egymástól függetlenül szorítandó
 EL Σφίγγετε εναλλάξ
 TR Dönuşümüli sikin

إحكام الربط بالتناوب
 חזק לסיבוב HE

ZH 交替拧紧
 JA 自動固定
 KO 번갈아 조이기
 TH ซับในแบบสลับ

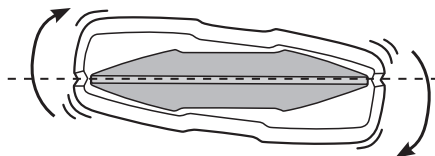
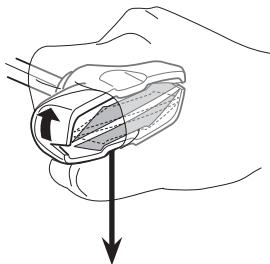
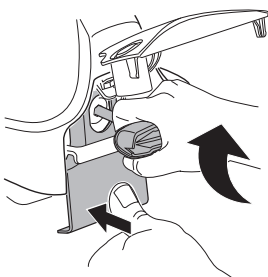
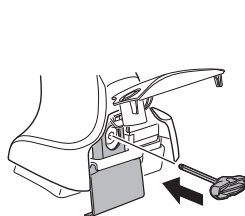

≈ 3 Nm

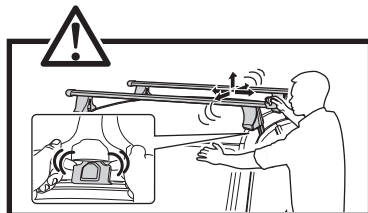
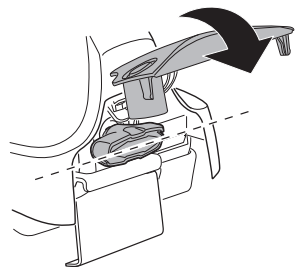

9



x1
17 mm

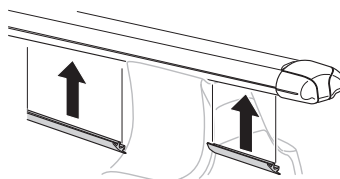
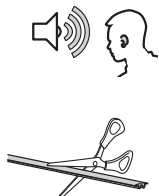

i

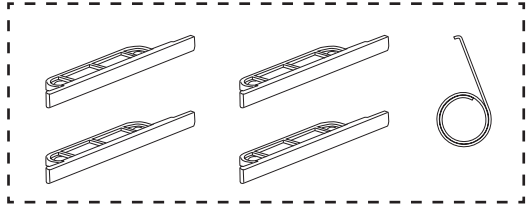
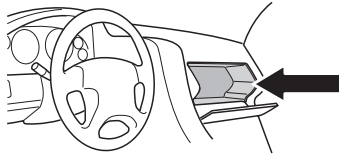

i

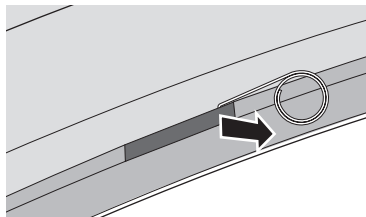
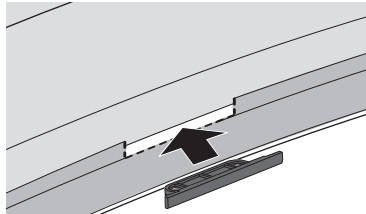
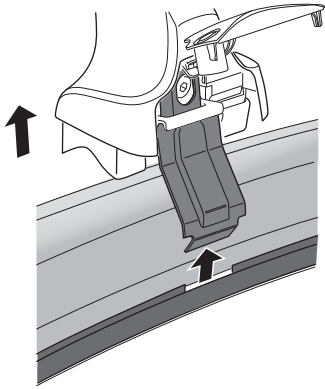
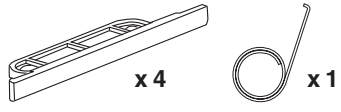
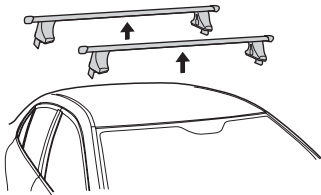

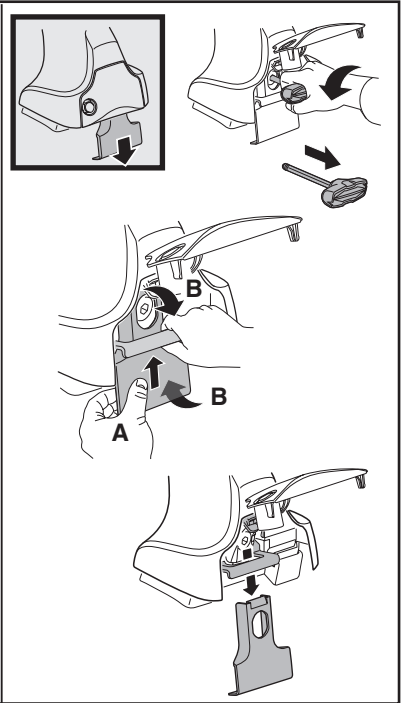
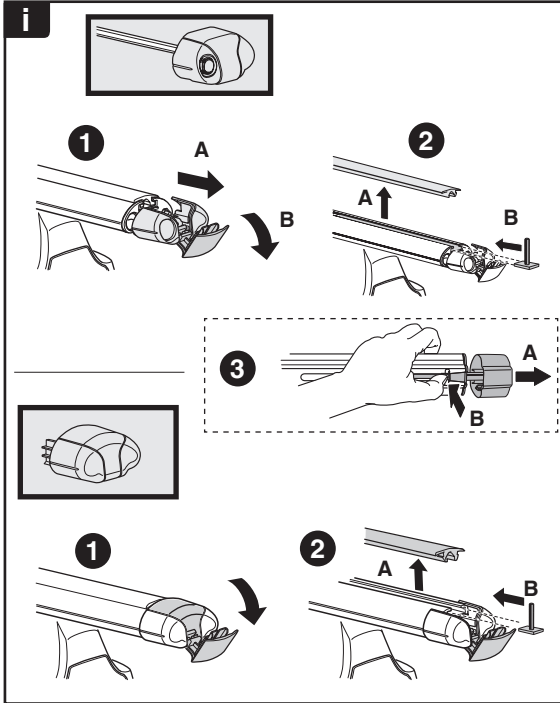
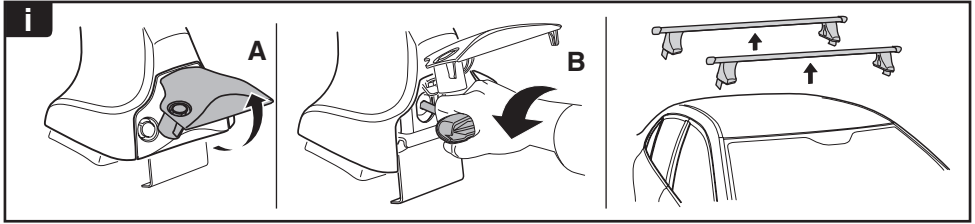

THULE
SWEDEN
**ONE
KEY
SYSTEM**

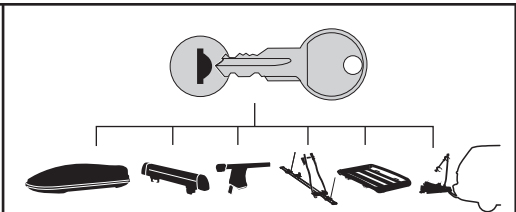

		(x4)
		(x6)
		(x8)
NA		(x10)
EUR		(x12)
ASIA		

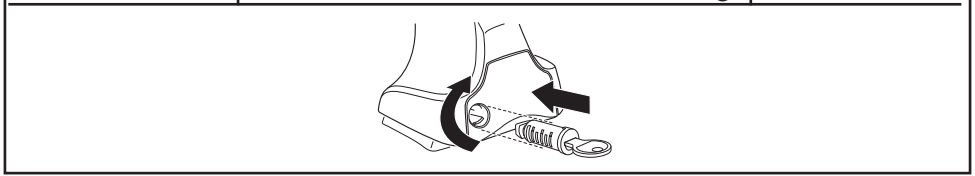

WW ▶ Thule Sweden AB, Box 69, 330 33 Hillerstorp, SWEDEN
NA ▶ Thule Inc., 42 Silvermine Road, Seymour, Connecticut 06483, USA

info@thule.com
customer.service@thule.com

www.thule.com