

Kit 1694

HYUNDAI i40, 4-dr Sedan, 11-



754 Rapid System
480R Rapid Traverse (North America)



480 Traverse (North America)



		<p>Max. 60 kg</p> <p>Max. 132 lbs</p>
--	--	---

		<p>80 km/h 50 Mph</p> <p>130 km/h 80 Mph</p> <p>40 km/h 25 Mph</p> <p>km/h Mph</p>
--	--	--

	<p>Kit XXXX</p> <p>instructions</p>	
--	---	--

x1

x4

754 Rapid System

x4

480R Rapid Traverse (North America)

x4

754 Rapid System

480R Rapid Traverse (North America)

x1

x4

480 Traverse (North America)

x4

<p>x2</p>	<p>x2</p> <p>23 mm</p>	<p>x1</p> <p>17 mm</p>	<p>x2</p> <p>23 mm</p>	<p>x2</p>
<p>x2</p>	<p>x2</p>	<p>x2</p> <p>23 mm</p>	<p>x2</p>	<p>x2</p>
	<p>x4</p>		<p>x2</p>	
	<p>x4</p>		<p>x2</p>	

(North America)

	<p>297</p>	<p>x2</p>		<p>269</p>	<p>x1</p>		<p>x1</p>
	<p>1163</p>	<p>x1</p>		<p>272</p>	<p>x1</p>		
	<p>1164</p>	<p>x1</p>		<p>366</p>	<p>x1</p>		
				<p>367</p>	<p>x1</p>		

1



2



754 Rapid System
480R Rapid Traverse
(North America)



x4

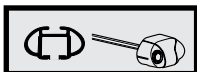

x4

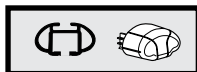

x4



480 Traverse
(North America)

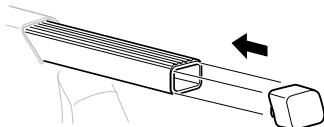

x4

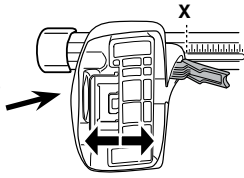
3**754** Rapid System

	X
HYUNDAI i40, 4-dr Sedan, 11-	43,5

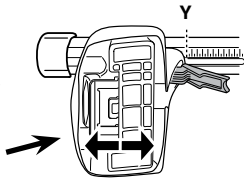

	Y
HYUNDAI i40, 4-dr Sedan, 11-	41,5

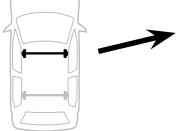
3**480R** Rapid Traverse**480** Traverse**(North America)**

	X inch	X mm
HYUNDAI i40, 4-dr Sedan, 11-	42 3/4"	1086 mm

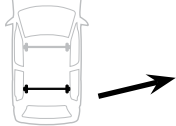

	Y inch	Y mm
HYUNDAI i40, 4-dr Sedan, 11-	42"	1066 mm

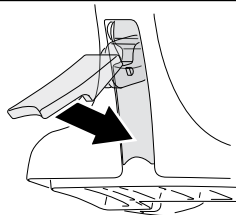
4

5

HYUNDAI i40, 4-dr Sedan, 11-

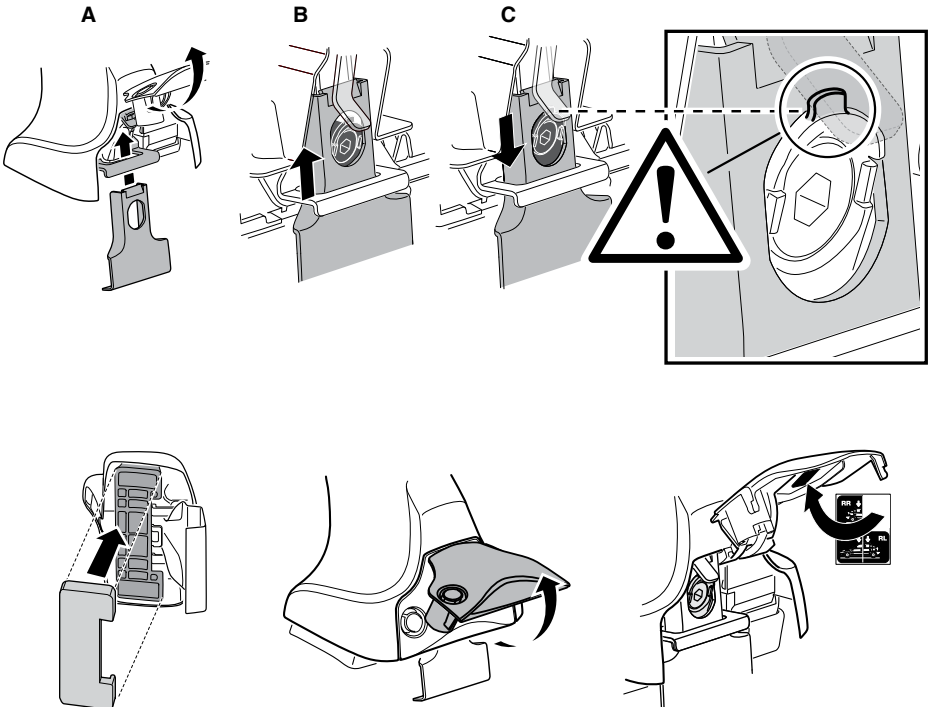
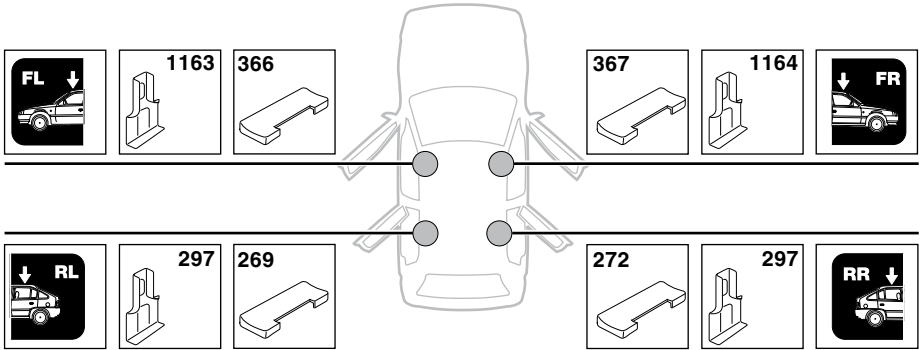

6

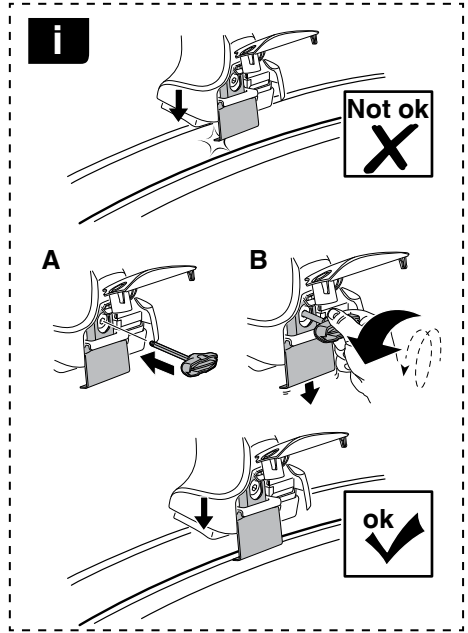

HYUNDAI i40, 4-dr Sedan, 11-

X mm	Y mm	X inch	Y inch
350 mm	700 mm	13 3/4"	27 1/2"

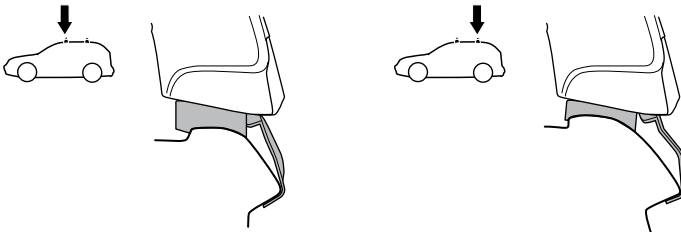
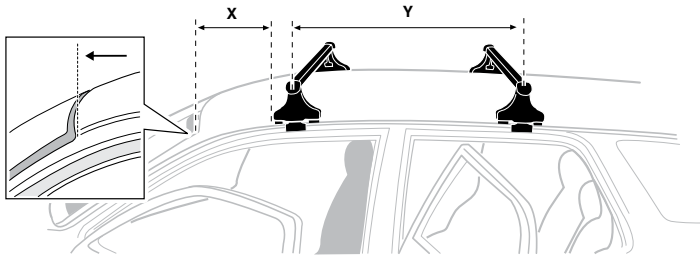

7



GB/US Tighten alternately
 D Die Schrauben abwechselnd anziehen
 F Serrer alternativement chaque côté
 NL Afwisselend aan de linker- en de rechterkant aandraaien
 I Alternare il serraggio delle viti
 E Apertar alternativamente
 PT Aperte alternadamente
 S Dra åt växelvis
 FIN Kierrä vuorotellen
 EST Pinguldage vaheldumisi
 LAT Pieļieciet pamišus
 LIT Užsukinėkite pakaitomis
 PL Śruby dokręcaj naprzemiennie
 RU Затягивайте попеременно

CZ Pokręťta bagażnika dokręcaj naprzemiennie.
 SK Dofahajte striedavo
 SLO Privijajte izmenično.
 HR Naizmjerno zategnite
 HU Egymástól függetlenül szorítandó
 GR Σφιγίγες εναλλάξ
 TR Dönüşümlü sıkın

中文 交替拧紧

한국어 번갈아 가며 조이십시오.

日本語 交互に締め付けてください。

ไทย ชันในแบบสลับ

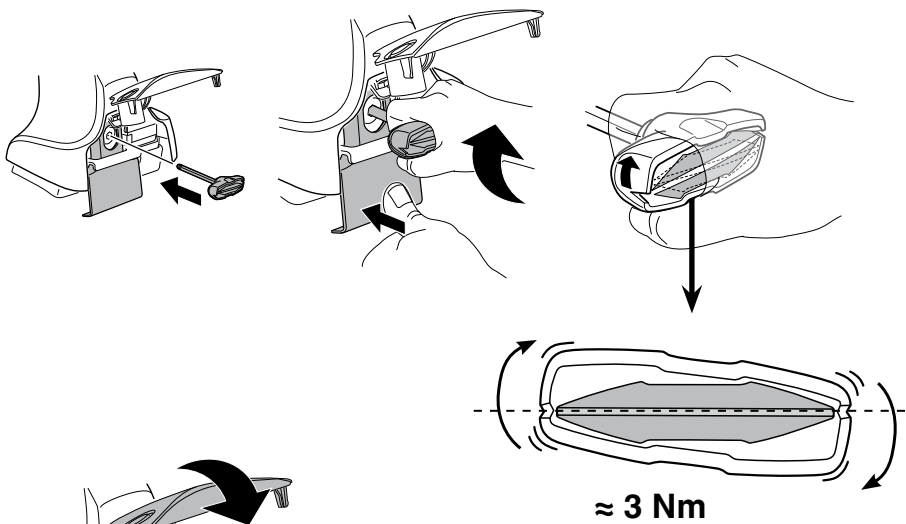



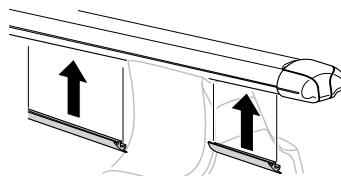
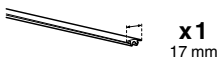

8





THULE
SWEDEN
**ONE
KEY
SYSTEM**



-  **544** (x4)
 -  **596** (x6)
 -  **588** (x8)
 -  **510** (x10)
 -  **452** (x12)
- NA
EUR
ASIA



WW ▶ Thule Sweden AB, Box 69, 330 33 Hillerstorp, SWEDEN
NA ▶ Thule Inc., 42 Silvermine Road, Seymour, Connecticut 06483, USA

info@thule.com
customer.service@thule.com

 www.thule.com