

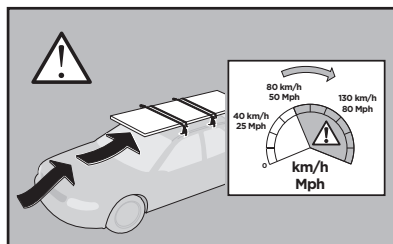

Thule Rapid System Kit 1783

> Instructions

CHEVROLET Colorado, 4-dr Crew Cab, 15-
CHEVROLET S10, 4-dr Double Cab, 12-
GMC Canyon, 4-dr Crew Cab, 15-
HOLDEN Colorado, 4-dr Double Cab, 12-
ISUZU D-Max, 4-dr Crew Cab, 12-

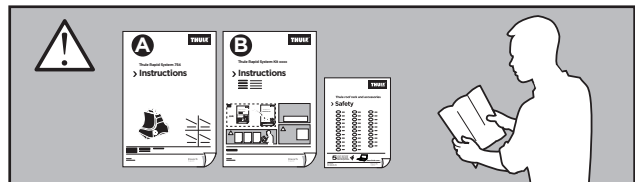
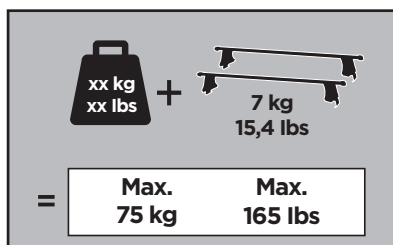
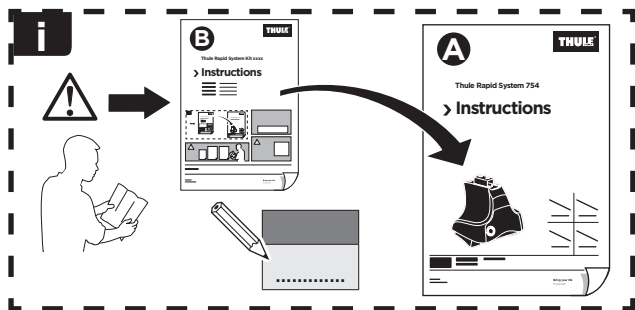

ISO 11154-E

141783
C.20150310
519-1783-01

Bring your life
thule.com



390 x2

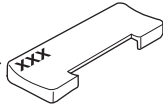

391 x1

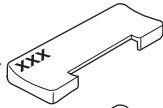

392 x1

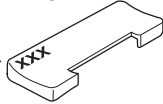

1234 x4

52597

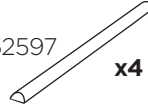

x4

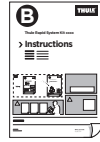

x1



x1

1

	X (scale)	X (mm)	X (inch)
CHEVROLET Colorado , 4-dr Crew Cab, 15-	38	1031	40 ⁵ / ₈
CHEVROLET S10 , 4-dr Double Cab, 12-	38	1031	40 ⁵ / ₈
GMC Canyon , 4-dr Crew Cab, 15-	38	1031	40 ⁵ / ₈
HOLDEN Colorado , 4-dr Double Cab, 12-	38	1031	40 ⁵ / ₈
ISUZU D-Max , 4-dr Crew Cab, 12-	38	1031	40 ⁵ / ₈

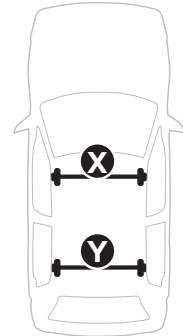
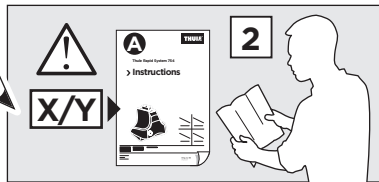
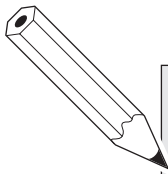

	Y (scale)	Y (mm)	Y (inch)
CHEVROLET Colorado , 4-dr Crew Cab, 15-	35.5	1006	39 ⁵ / ₈
CHEVROLET S10 , 4-dr Double Cab, 12-	35.5	1006	39 ⁵ / ₈
GMC Canyon , 4-dr Crew Cab, 15-	35.5	1006	39 ⁵ / ₈
HOLDEN Colorado , 4-dr Double Cab, 12-	35.5	1006	39 ⁵ / ₈
ISUZU D-Max , 4-dr Crew Cab, 12-	35.5	1006	39 ⁵ / ₈

2

CHEVROLET Colorado, 4-dr Crew Cab, 15-
CHEVROLET S10, 4-dr Double Cab, 12-
GMC Canyon, 4-dr Crew Cab, 15-
HOLDEN Colorado, 4-dr Double Cab, 12-
ISUZU D-Max, 4-dr Crew Cab, 12-

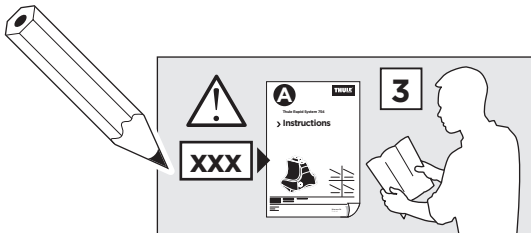
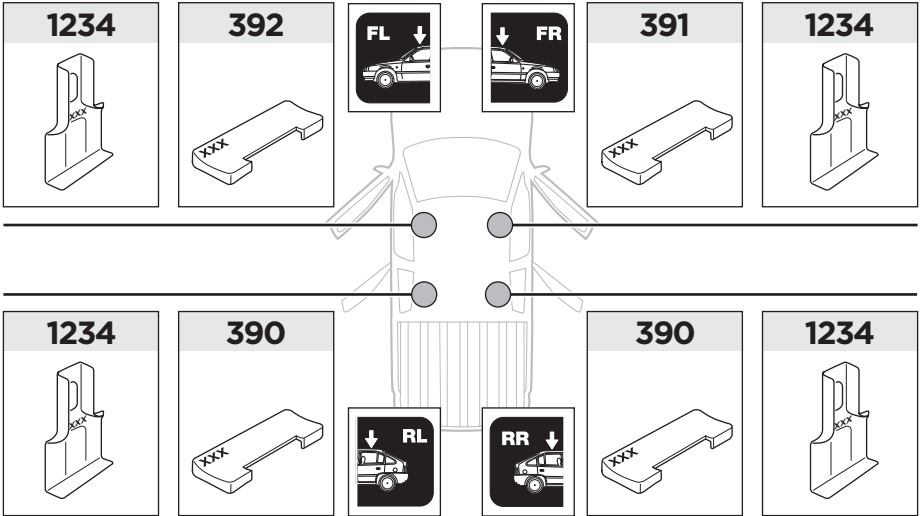

3

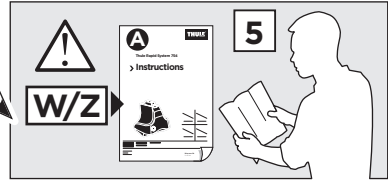

	W (mm)	Z (mm)	W (inch)	Z (inch)
CHEVROLET Colorado , 4-dr Crew Cab, 15-	250	700	9 7/8	27 1/4
CHEVROLET S10 , 4-dr Double Cab, 12-	250	700	9 7/8	27 1/4
GMC Canyon , 4-dr Crew Cab, 15-	250	700	9 7/8	27 1/4
HOLDEN Colorado , 4-dr Double Cab, 12-	250	700	9 7/8	27 1/4
ISUZU D-Max , 4-dr Crew Cab, 12-	250	700	9 7/8	27 1/4

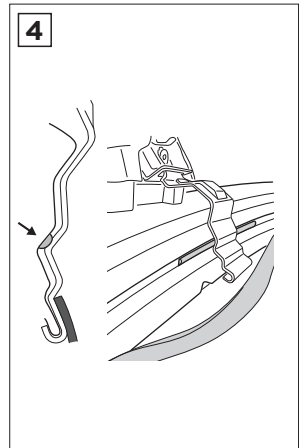
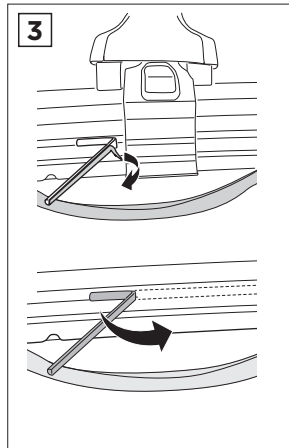
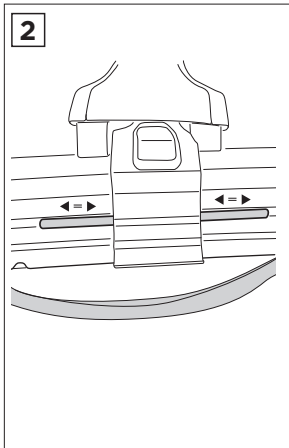
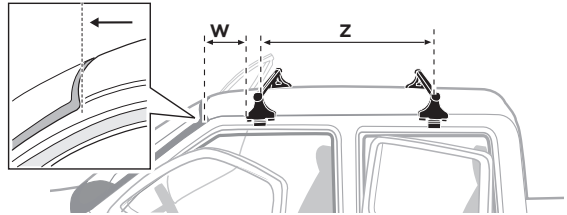
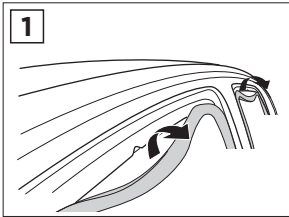

4

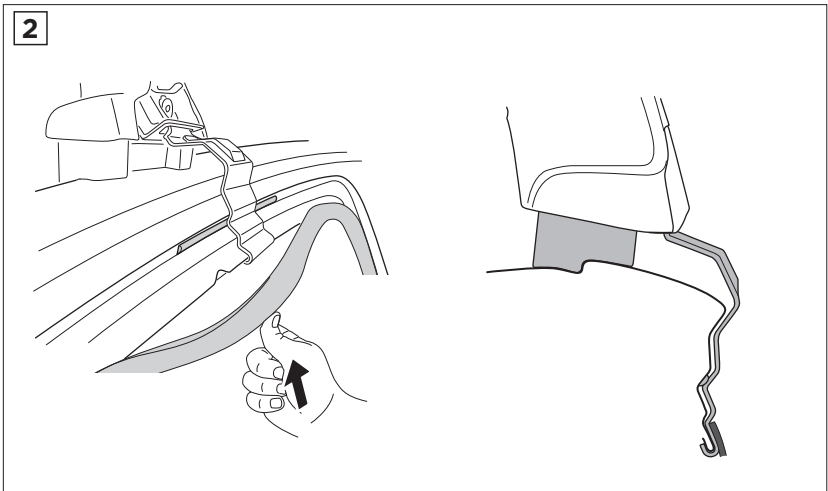
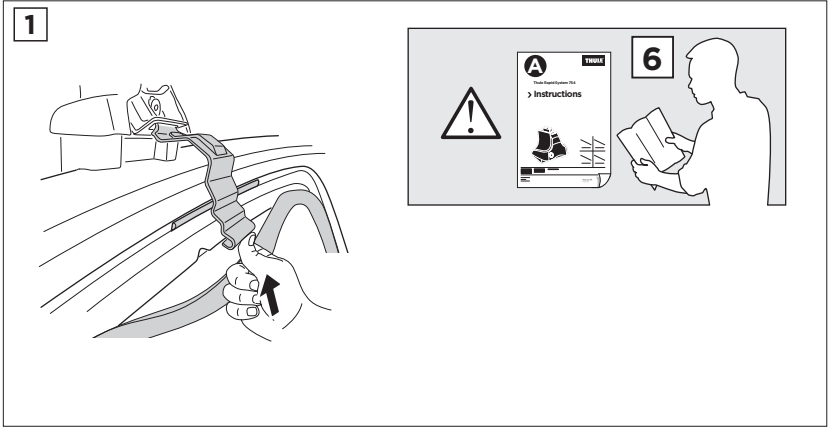

Thule Sweden AB, Box 69, 330 33 Hillerstorp, SWEDEN
Thule Inc., 42 Silvermine Road, Seymour, Connecticut 06483, USA

info@thule.com
Phone: 800-238-2388

 www.thule.com

» PART OF THULE GROUP

© Thule Group 2015. All rights reserved.

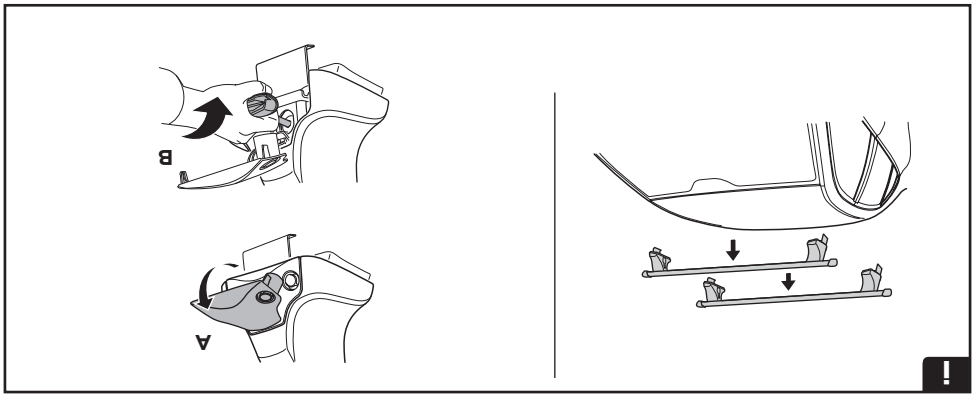
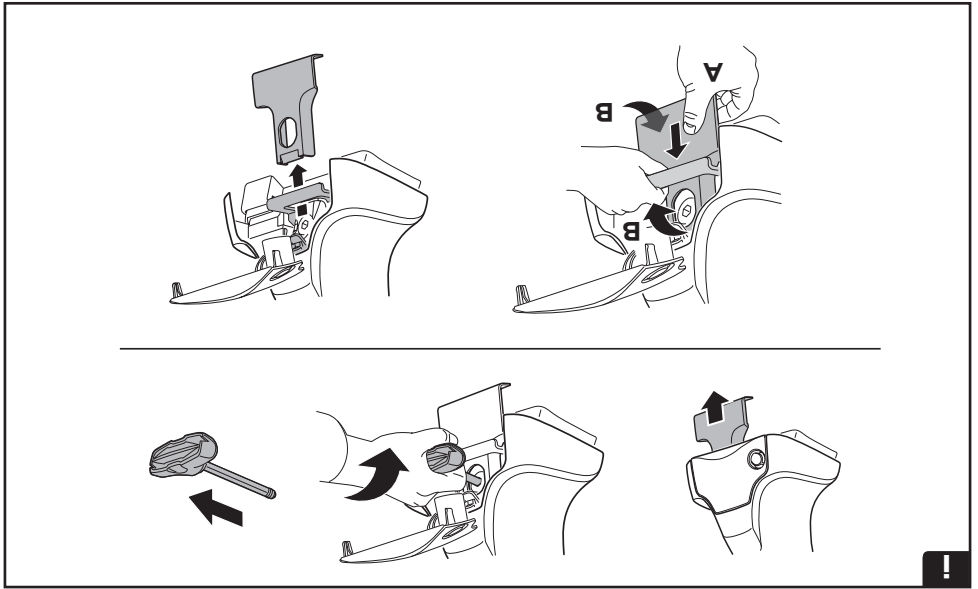

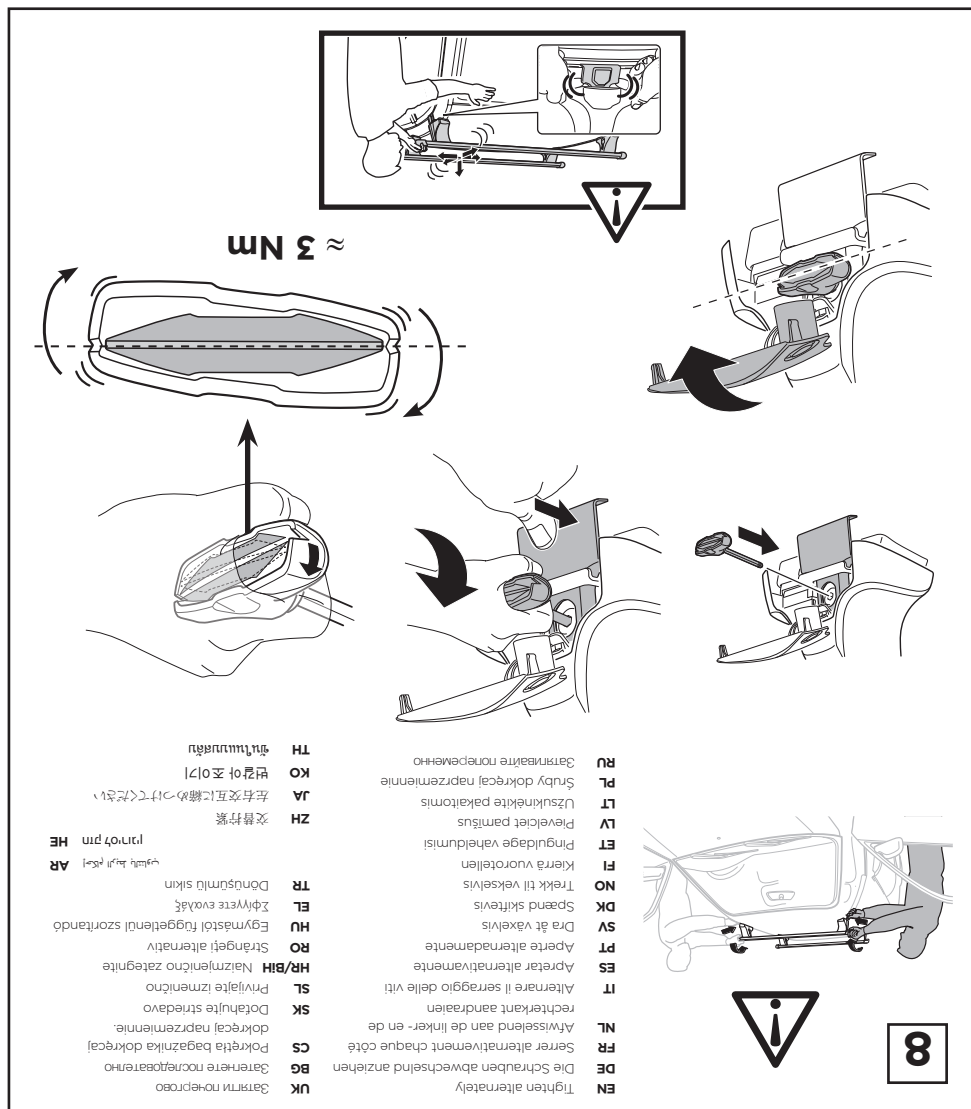
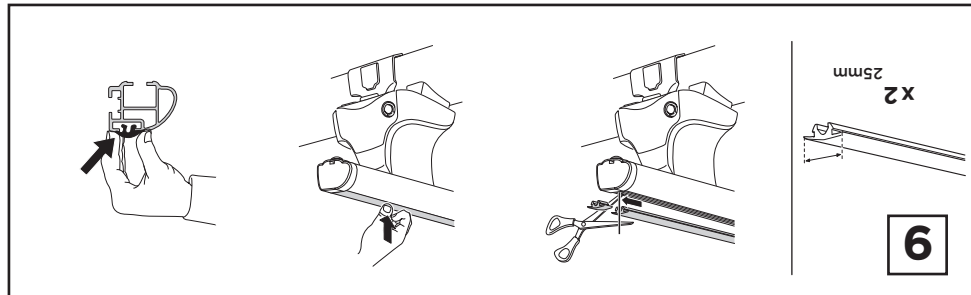

≈ 3 Nm

- UK Сатрын папэрава
- BG Замеһне покрывава
- FR Serrer alternatifement chaque côté
- CS Pokrýtá bagazníka dokřećal
- SK Dotáňujte štredavo
- SL Privijajte izmenično
- HR/BIH Naizmjenično zategnite
- RO Strângereți alternativ
- HU Egyarástól függetlenül szorítandó
- EL Σφύγγετε εναλλάξ
- TR Dönüşümlü sıkın
- AR انحرطوا بترتيب
- HE פרוטן גרמ
- ZH 交替拧紧
- JA 左右交互に締めつけてください
- KO 좌우가 교대로
- TH วนทิศทาง

- EN Tighten alternately
- DE Die Schrauben abwechselnd anziehen
- FR Serrer alternativement chaque côté
- NL Afwisselend aan de linker- en de rechterkant aandraaien
- IT Alternare il serraggio delle viti
- ES Aprete alternativamente
- PT Aperte alternadamente
- SV Dra åt växelvis
- DK Spænd skiftevis
- NO Trekk til vekselvis
- FI Kierä vuorotellen
- ET Pinguldage vaheldumisi!
- LV Pieveicēt pamīsus
- LT Užsukinkite pakaitomis
- PL Srdub dokřećal naprzemiennie
- RU Замеһайте попеременно

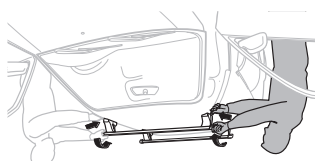

8

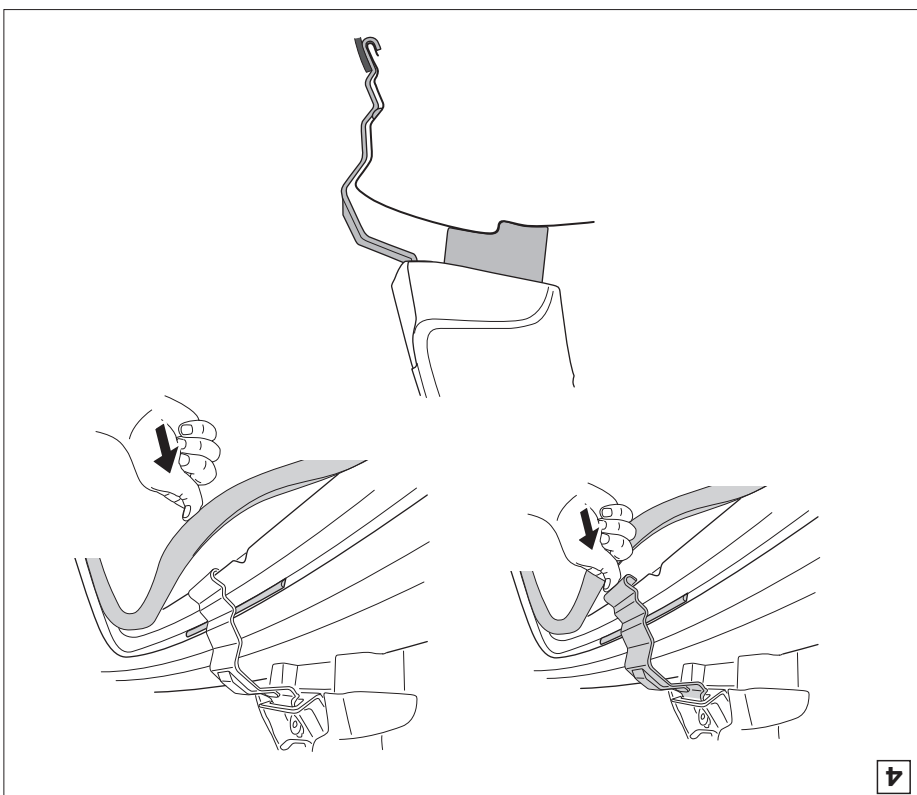

4

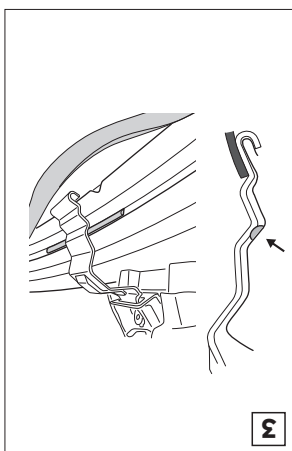

3

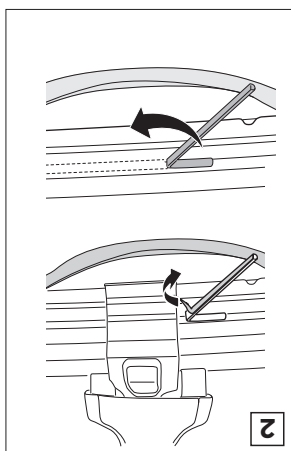

2

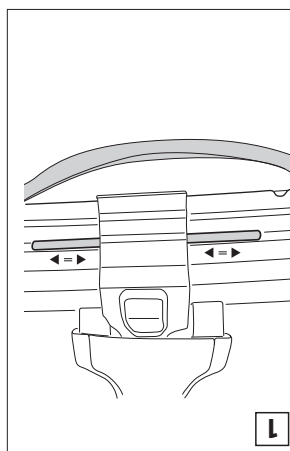

1

7

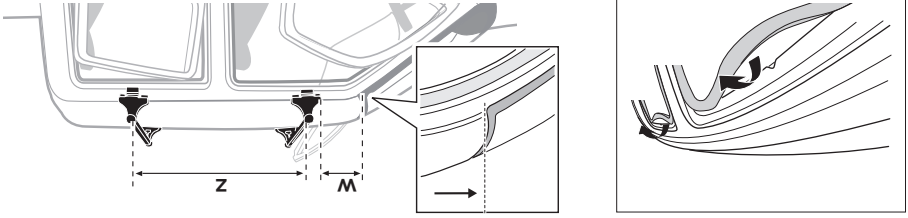

	X mm	Y mm	X inch	Y inch
CHEVROLET Colorado, 4-dr Crew Cab, 15-	250 mm	700 mm	9 7/8"	27 1/2"
CHEVROLET S10, 4-dr Double Cab, 12-	250 mm	700 mm	9 7/8"	27 1/2"
GMC Canyon, 4-dr Crew Cab, 15-	250 mm	700 mm	9 7/8"	27 1/2"
HOLDEN Colorado, 4-dr Double Cab, 12-	250 mm	700 mm	9 7/8"	27 1/2"
ISUZU D-Max, 4-dr Crew Cab, 12-	250 mm	700 mm	9 7/8"	27 1/2"

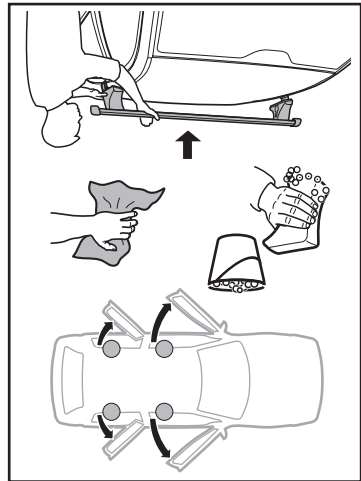
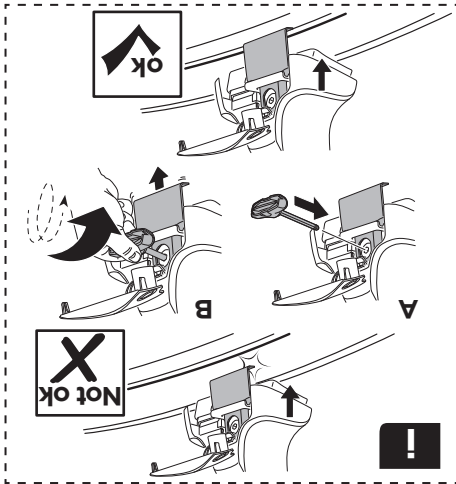

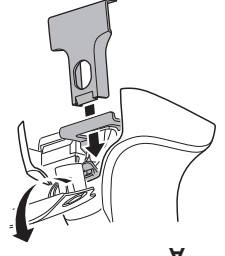
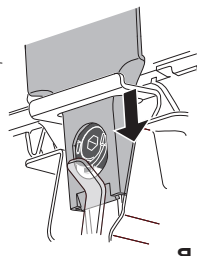
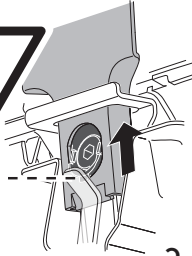
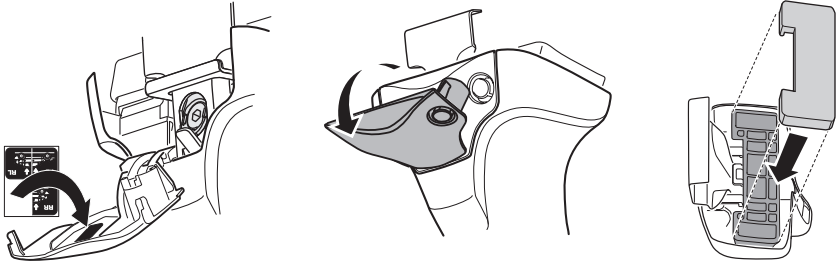

A

B

C

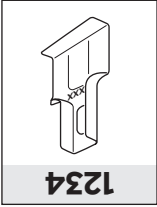

1234

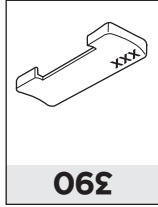

390



RR
↑



RL
↑

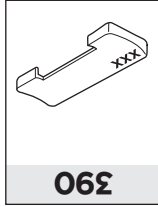

390

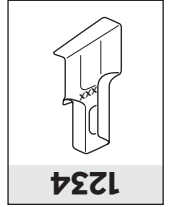

1234

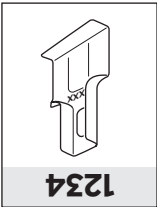

1234

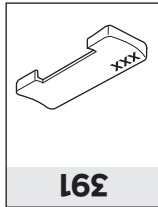

391



FR
↑



FL
↑

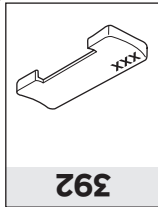

392

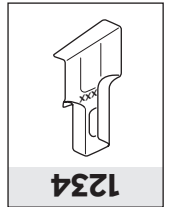

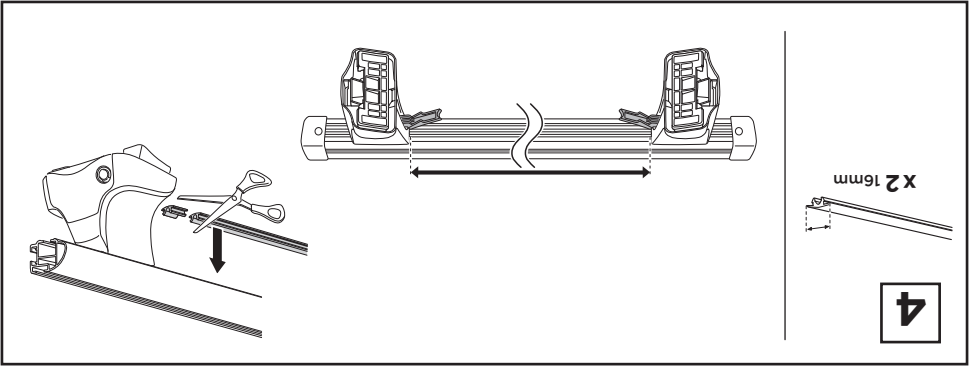

1234

- CHEVROLET Colorado, 4-dr Crew Cab, 15-
- CHEVROLET S10, 4-dr Double Cab, 12-
- GMC Canyon, 4-dr Crew Cab, 15-
- HOLDEN Colorado, 4-dr Double Cab, 12-
- ISUZU D-Max, 4-dr Crew Cab, 12-



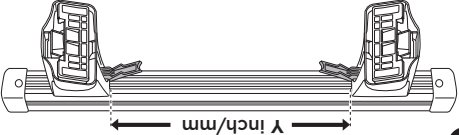

1006	35,5	ISUZU D-Max, 4-dr Crew Cab, 12-
1006	35,5	HOLDEN Colorado, 4-dr Double Cab, 12-
1006	35,5	GMC Canyon, 4-dr Crew Cab, 15-
1006	35,5	CHEVROLET S10, 4-dr Double Cab, 12-
1006	35,5	CHEVROLET Colorado, 4-dr Crew Cab, 15-

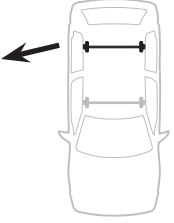
Y inch Y mm



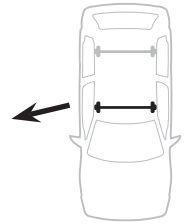
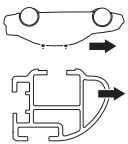

1031	38	ISUZU D-Max, 4-dr Crew Cab, 12-
1031	38	HOLDEN Colorado, 4-dr Double Cab, 12-
1031	38	GMC Canyon, 4-dr Crew Cab, 15-
1031	38	CHEVROLET S10, 4-dr Double Cab, 12-
1031	38	CHEVROLET Colorado, 4-dr Crew Cab, 15-

X inch X mm

3

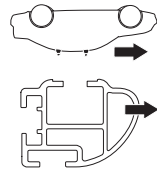
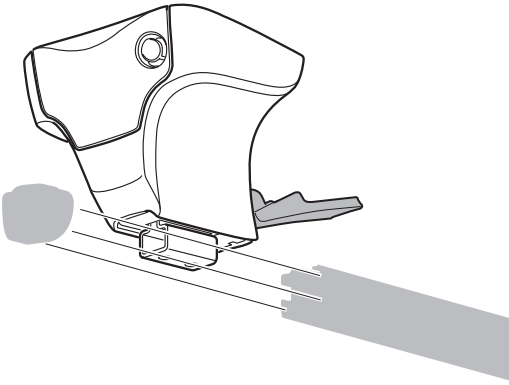
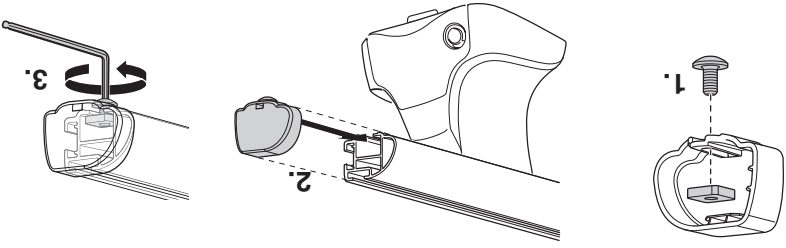

2

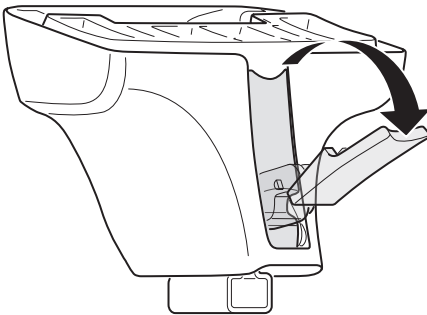

1

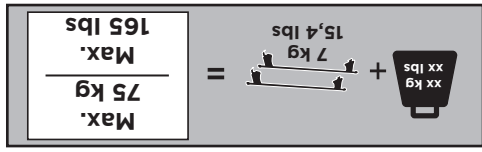
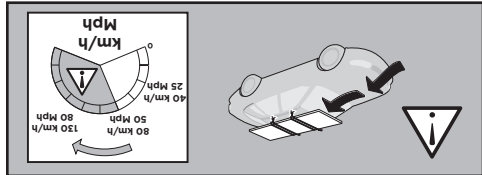
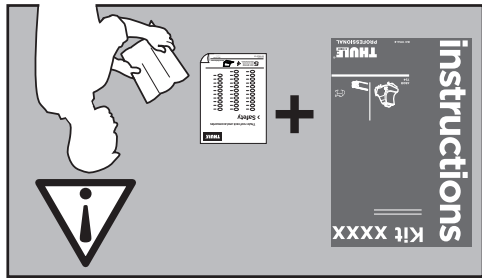
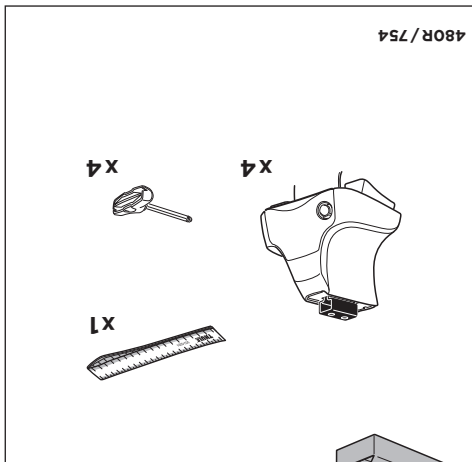
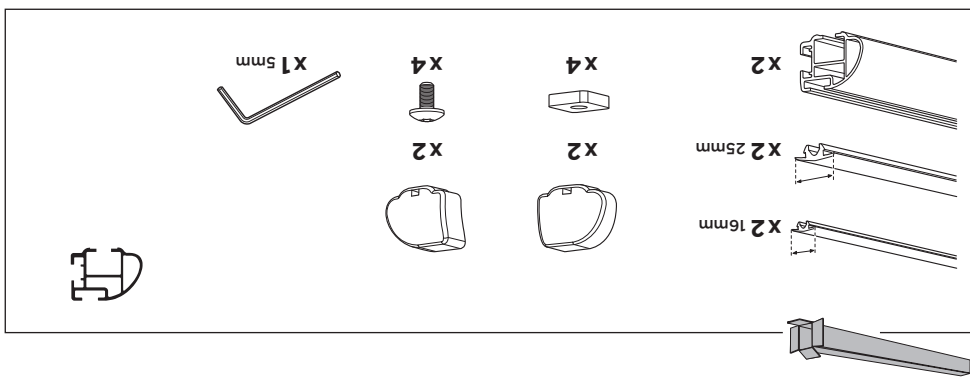
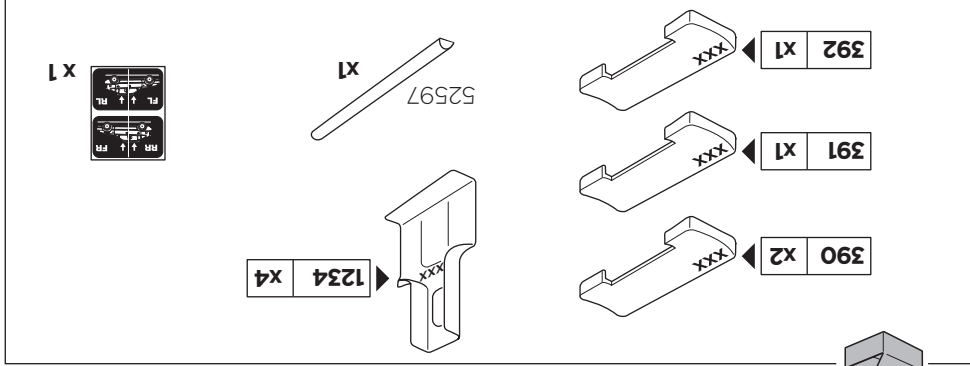

instructions

Kit 1783

- CHEVROLET Colorado, 4-dr Crew Cab, 15-
- CHEVROLET S10, 4-dr Double Cab, 12-
- GMC Canyon, 4-dr Crew Cab, 15-
- HOLDEN Colorado, 4-dr Double Cab, 12-
- ISUZU D-Max, 4-dr Crew Cab, 12-

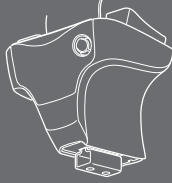

480R
754

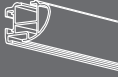

ISO 11154-E

PROFESSIONAL

THULE
SWEDEN