

# Kit 3007

**VW Polo**, 3-dr Hatchback, 95-01

**VW Polo**, 5-dr Hatchback, 95-01

**VW Caddy (Mk.II)**, 3-dr Van, 96-03

**VW Caddy (Mk.II)**, 3-dr Estate, 96-03

**SEAT Inca (Mk.II)**, 3-dr Van, 96-03

**SEAT Inca (Mk.II)**, 3-dr Estate, 96-03

**This Kit is only for vehicles with fixpoint mounting.**

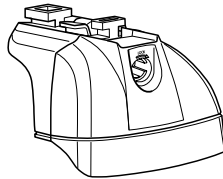

**460R  
753**

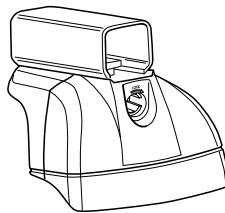
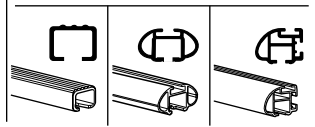

**460**

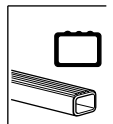

VW Polo, 3-dr Hatchback, 95-01  
 VW Polo, 5-dr Hatchback, 95-01

**Max.**  
**50kg/110 lbs**

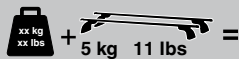

VW Caddy (Mk.II), 3-dr Van, 96-03  
 VW Caddy (Mk.II), 3-dr Estate, 96-03  
 SEAT Inca (Mk.II), 3-dr Van, 96-03  
 SEAT Inca (Mk.II), 3-dr Estate, 96-03

**Max.**  
**70kg/154 lbs**

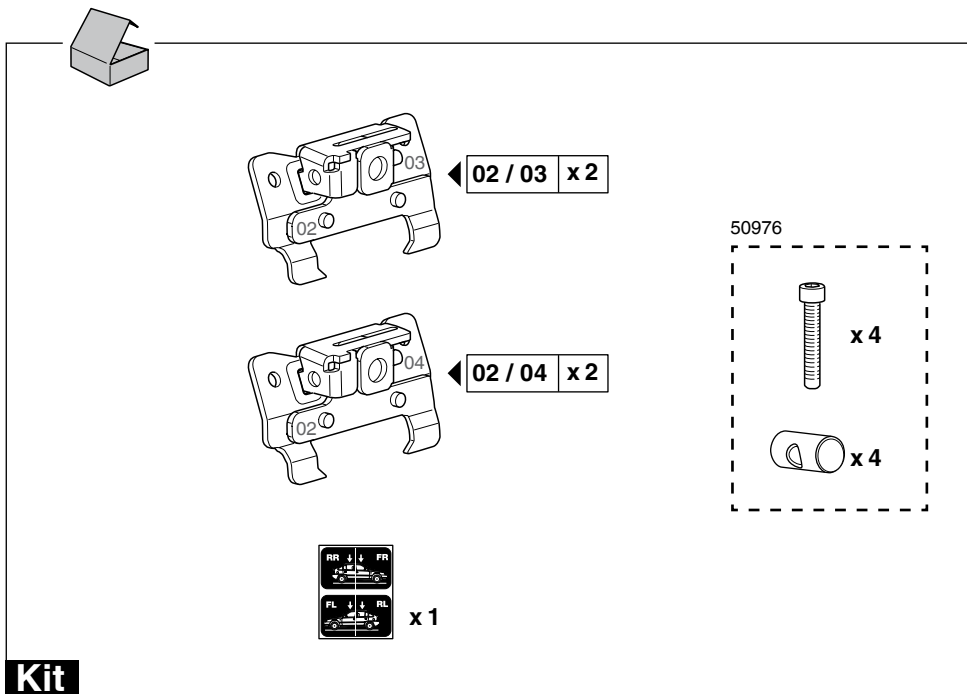
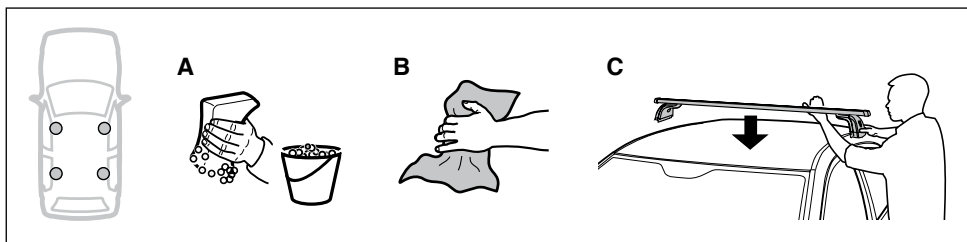
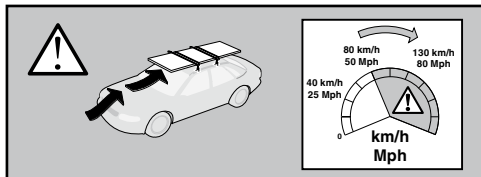
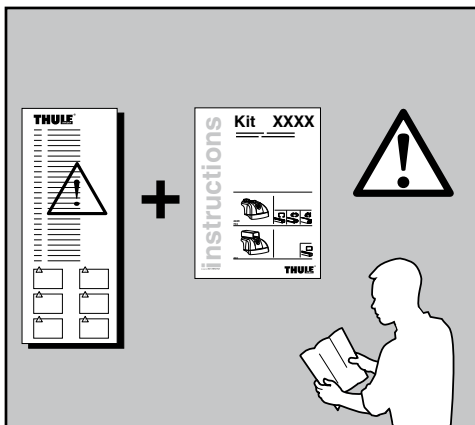

**Kit**



753

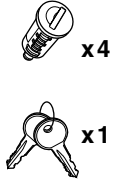
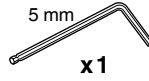
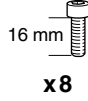
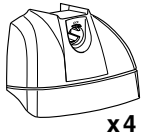

460R

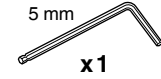
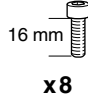
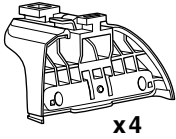

460

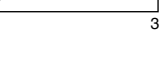
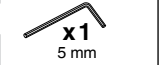
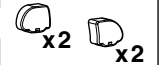
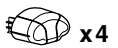
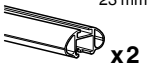
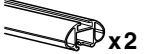
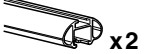
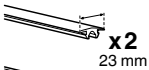
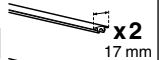
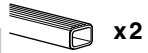
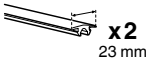
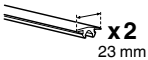
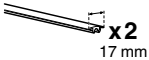
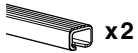
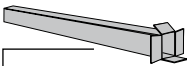
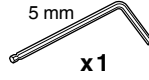
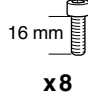
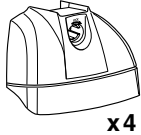
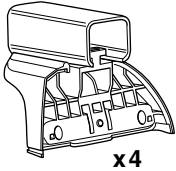

1

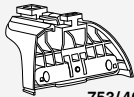

753/460R

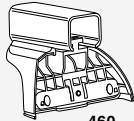

460

+

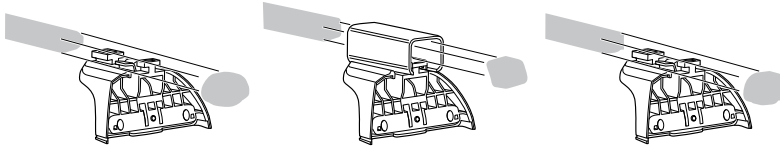

x4

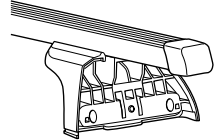
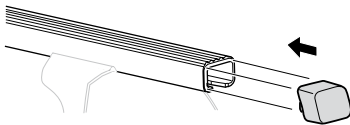

x4

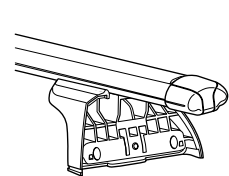
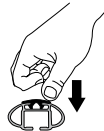
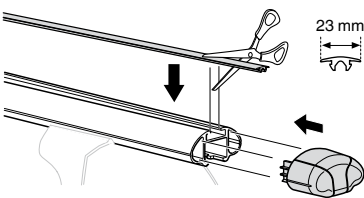

x4

x4

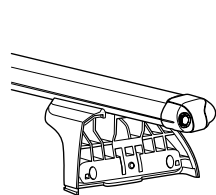
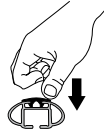
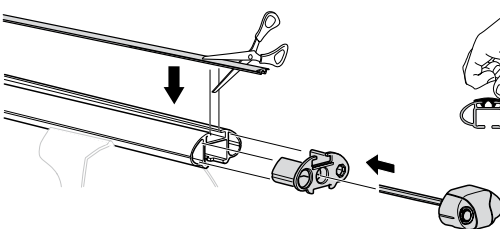

x4

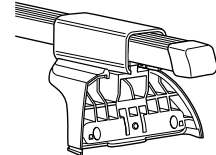
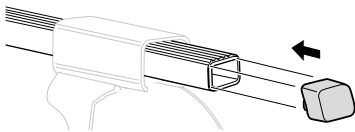

x2

x2

x4

x4

x1  
5 mm

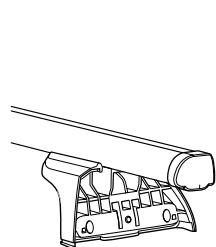
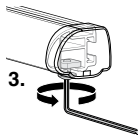
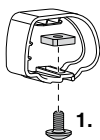
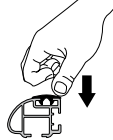
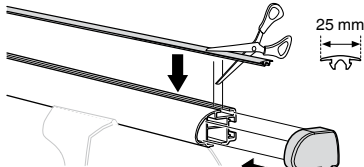

2

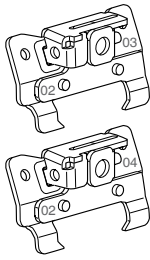

02 / 03 x 2

02 / 04 x 2

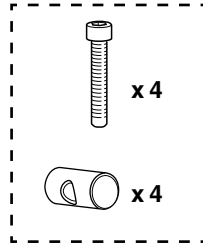

x 4

x 4

16 mm x 8



x 1



02 / 04



FL

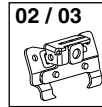

02 / 03



FR

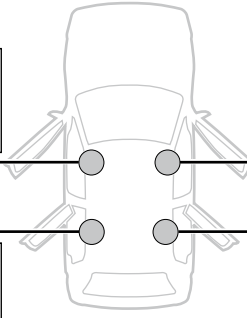

02 / 03



RL

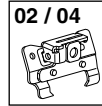

02 / 04



RR

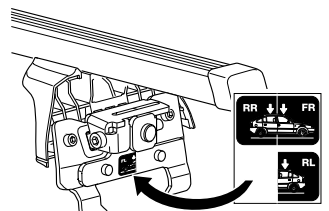
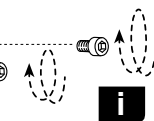
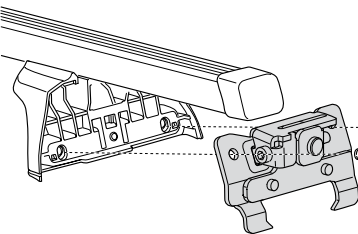
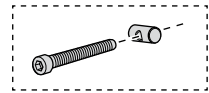
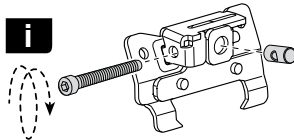
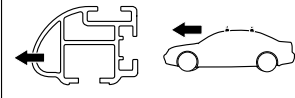

**GB** Only a few turns  
**D** Nur wenige Umdrehungen  
**F** Quelques tours uniquement  
**NL** Slechts enkele slagen  
**I** Solo qualche giro  
**E** Sólo algunas vueltas  
**PT** Noções básicas  
**S** Endast några varv  
**FIN** Vain muutama kierros

**EST** Ainult mõni pööre  
**LAT** Tikai dažī apgriezieni  
**LIT** Tik keli pasukimai  
**PL** Wystarczy kilka obrotów  
**RU** Достаточно нескольких оборотов  
**CZ** Pouze několik otáček  
**SK** Len niekoľko otáčok  
**SLO** Le nekaj obratov

**HR** Samo nekoliko okreta  
**HU** Csak néhány fordítás  
**GR** Μόνο μερικές στροφές  
**TR** Yalnız birkaç kez çevirm  
**中文** 只有几个转向  
**한국어** 두 세번만  
**日本語** 数回転のみ  
**ไทย** หมุนเพียงไม่กี่รอบ

3

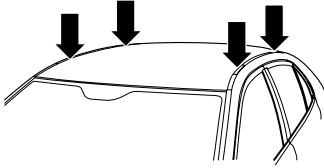

**VW Polo,**  
3-dr Hatchback, 95-00  
**VW Polo,**  
5-dr Hatchback, 95-00

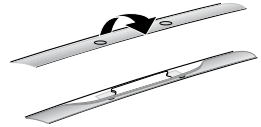

**VW Polo,**  
3-dr Hatchback, 00-01  
**VW Polo,**  
5-dr Hatchback, 00-01

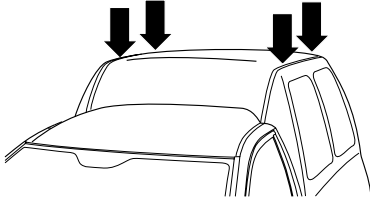
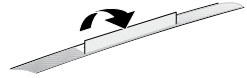

**VW Caddy (Mk.II),**  
3-dr Van, 96-03  
**VW Caddy (Mk.II),**  
3-dr Estate, 96-03  
**SEAT Inca (Mk.II),**  
3-dr Van, 96-03  
**SEAT Inca (Mk.II),**  
3-dr Estate, 96-03

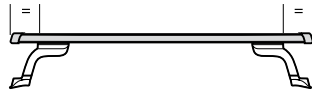
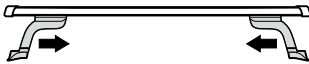
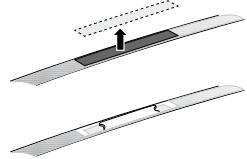

A

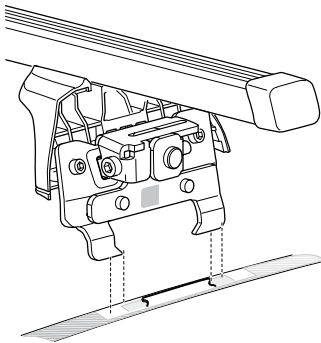

B

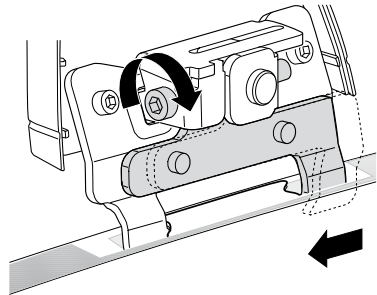

C

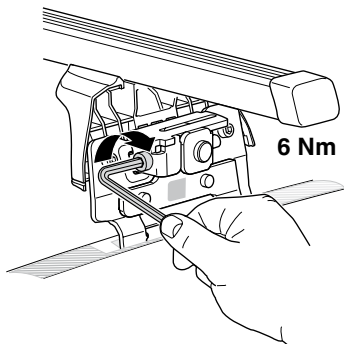

D

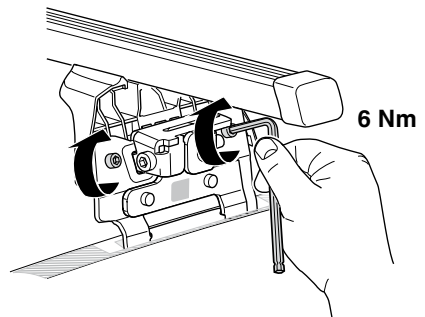

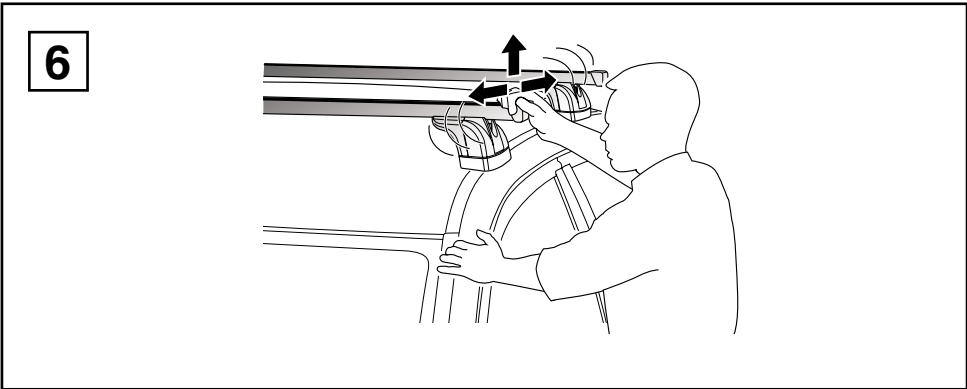
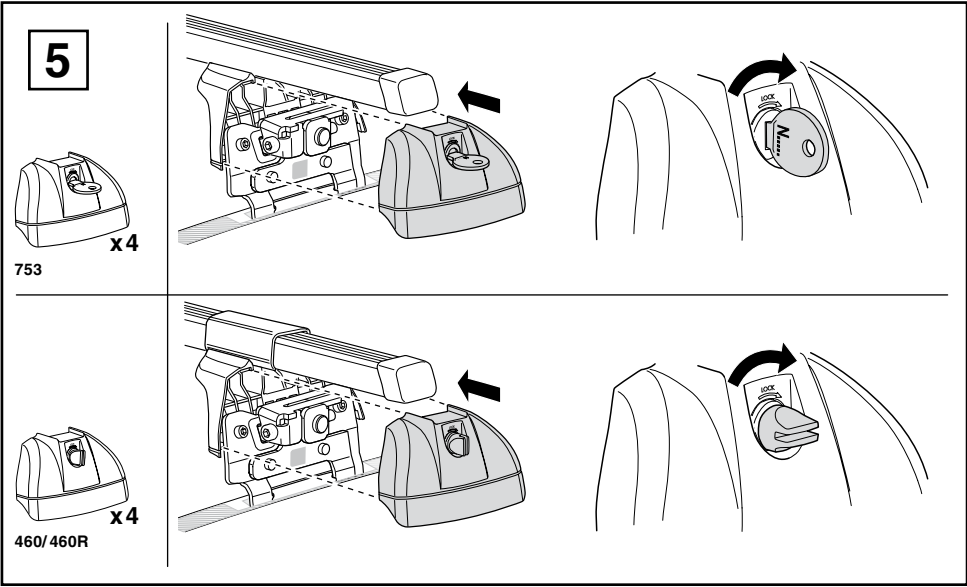
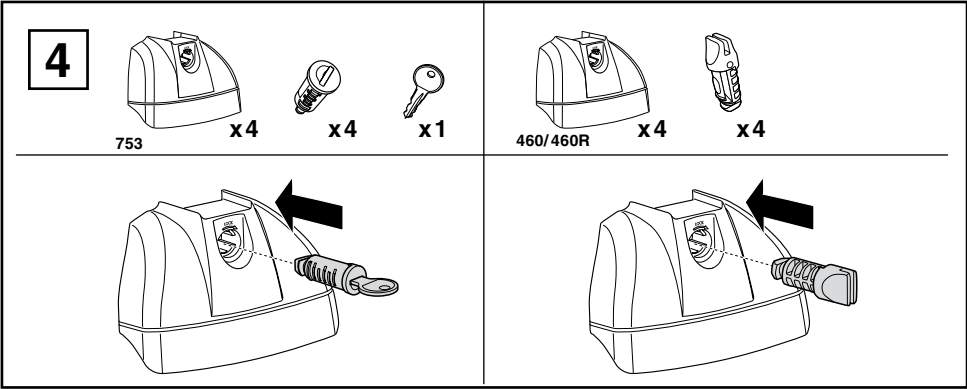

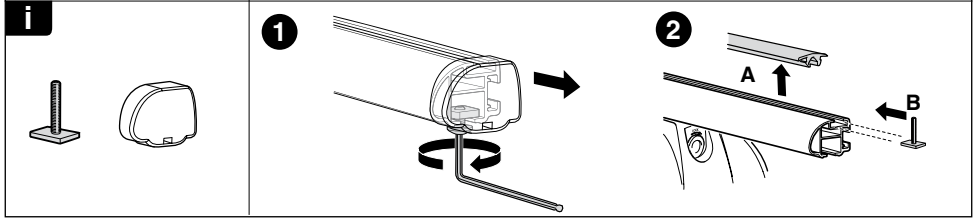
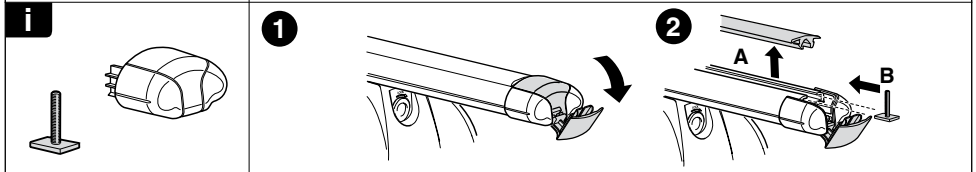
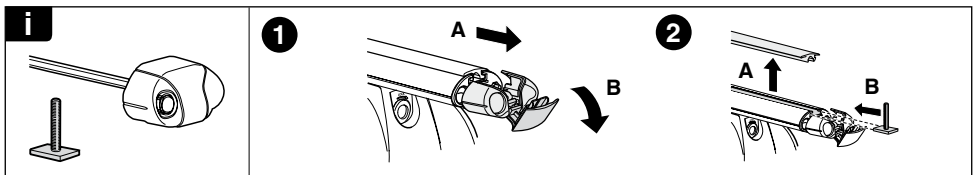
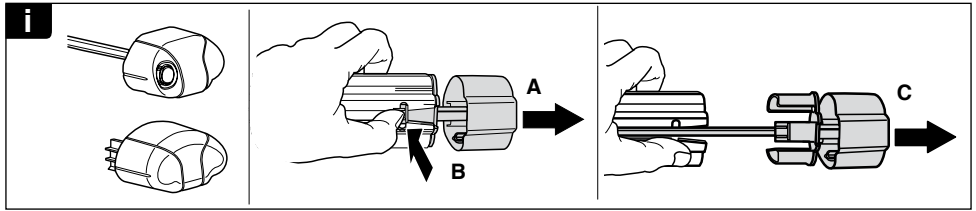
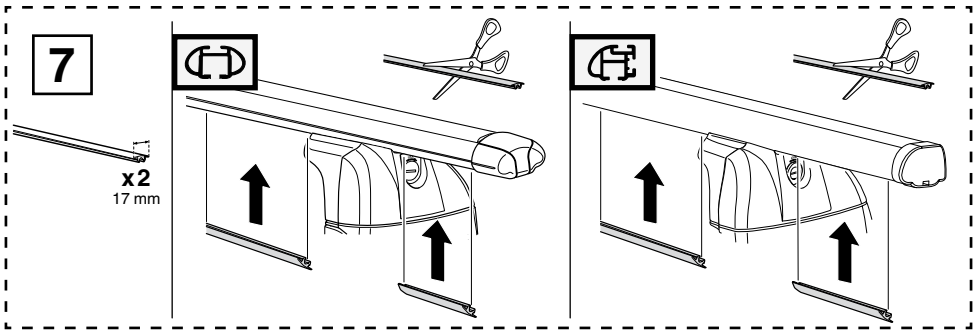

**THULE**  
SWEDEN  
**ONE  
KEY  
SYSTEM**

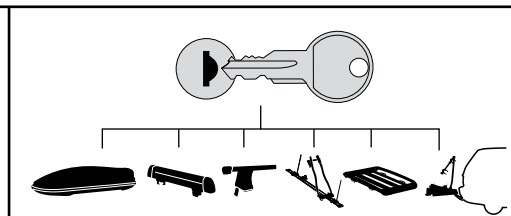

- 544 (x4)
- 596 (x6)
- 588 (x8)
- NA 510 (x10)
- EUR ASIA 452 (x12)