

Kit 3025

OPEL Astra, 5-dr Hatchback, 04-09

OPEL Astra, 3-dr Hatchback, 04-09

OPEL Zafira, 5-dr MPV, 05–

HOLDEN Astra, 5-dr Hatchback, 04-09

HOLDEN Astra, 3-dr Hatchback, 04-09

HOLDEN Zafira, 5-dr MPV, 05–

VAUXHALL Astra, 5-dr Hatchback, 04-09

VAUXHALL Astra, 3-dr Hatchback, 04-09

VAUXHALL Zafira, 5-dr MPV, 05–

SATURN Astra, 5-dr Hatchback, *08–

SATURN Astra, 3-dr Hatchback, *08–

*North America

This Kit is only for vehicles with fixpoint mounting.

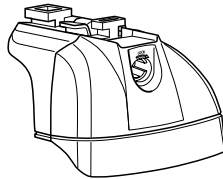

**460R
753**

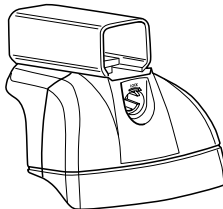

460

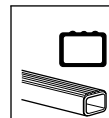

Kit



753



x4



x4



x4



x8

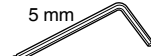

x1



x4



x1

460R

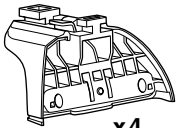

x4



x4



x4



x8



x1



x4

460

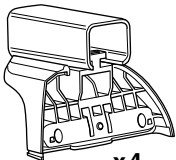

x4



x4



x4



x8



x1



x4

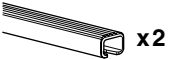

x2



x2

17 mm

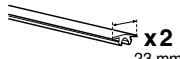

x2

23 mm



x2

23 mm



x2

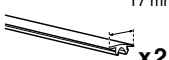

x2

23 mm

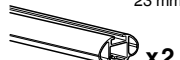

x2



x2



x4



x4



x4

1

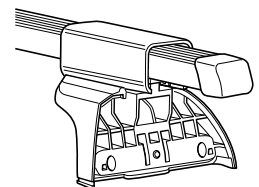
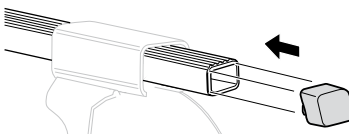
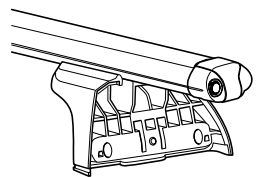
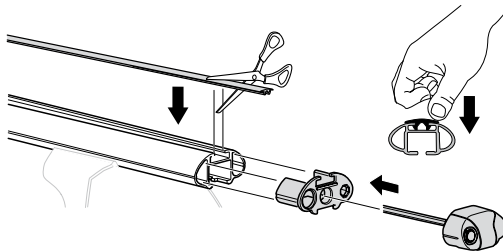
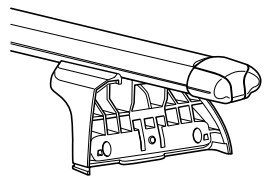
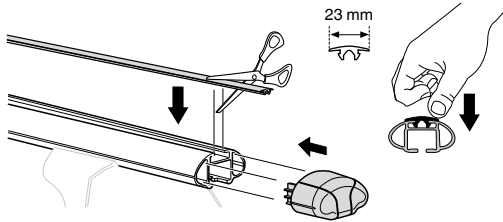
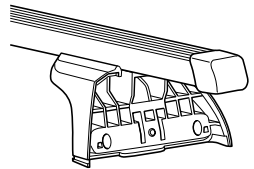
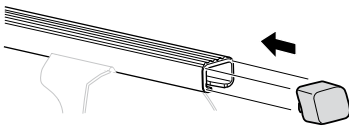
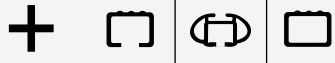

2

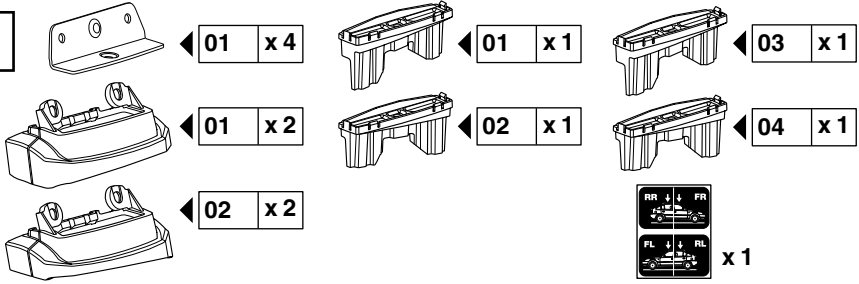

- OPEL Astra,**
5-dr Hatchback, 04-09
- OPEL Astra,**
3-dr Hatchback, 04-09
- HOLDEN Astra,**
5-dr Hatchback, 04-09
- HOLDEN Astra,**
3-dr Hatchback, 04-09
- VAUXHALL Astra,**
5-dr Hatchback, 04-09
- VAUXHALL Astra,**
3-dr Hatchback, 04-09
- SATURN Astra,**
5-dr Hatchback, *08-
- SATURN Astra,**
3-dr Hatchback, *08-

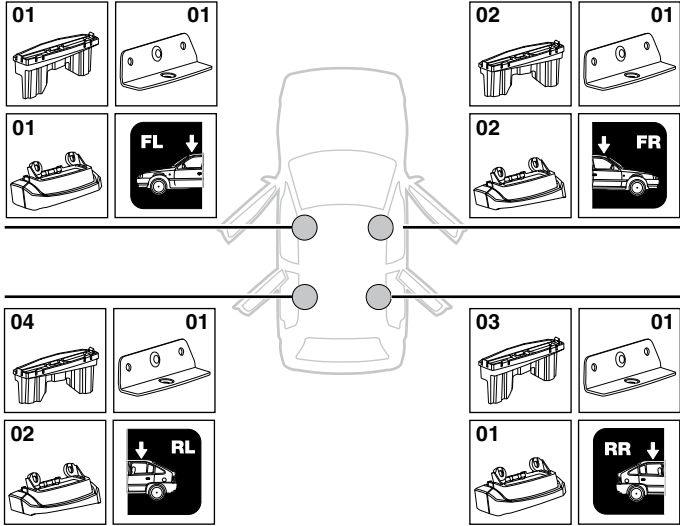

- OPEL Zafira,**
5-dr MPV, 05-
- HOLDEN Zafira,**
5-dr MPV, 05-
- VAUXHALL Zafira,**
5-dr MPV, 05-

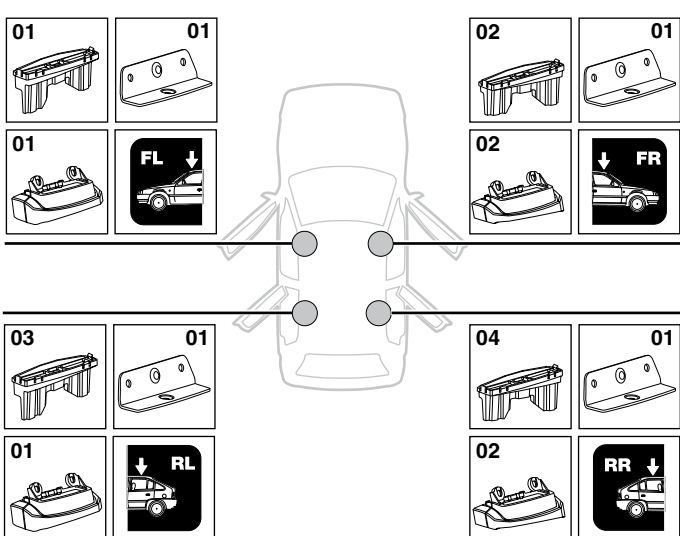

3

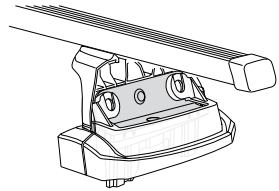
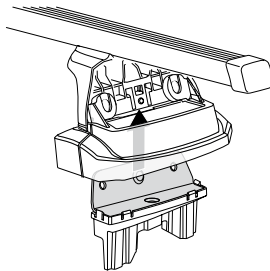
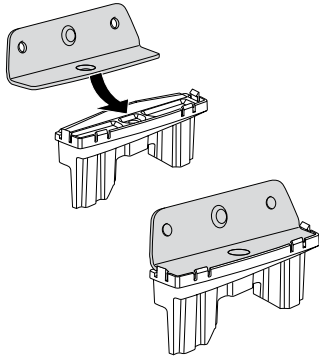
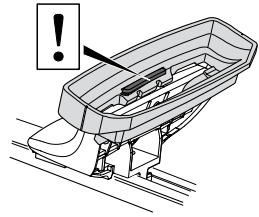
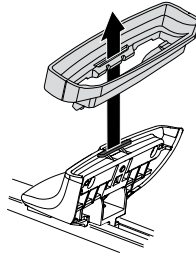
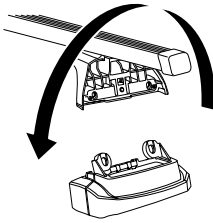

16 mm x 8

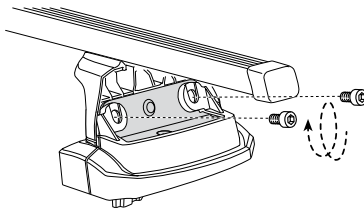

GB Only a few turns
D Nur wenige Umdrehungen
F Quelques tours uniquement
NL Slechts enkele slagen
I Solo qualche giro
E Sólo algunas vueltas
PT Noções básicas
S Endast några varv
FIN Vain muutama kierros

EST Ainult mõni pööre
LAT Tikai dažī apgriezieni
LIT Tik keli pasukimai
PL Wystarczy kilka obrotów
RU Достаточно нескольких оборотов
CZ Pouze několik otáček
SK Len niekoľko otáčok
SLO Le nekaj obratov

HR Samo nekoliko okreta
HU Csak néhány fordítás
GR Μόνο μερικές στροφές
TR Yalnız birkaç kez çevirm
中文 只有几个转向
한국어 두 세 번만
日本語 数回転のみ
ไทย หมุนเพียงไม่กี่รอบ

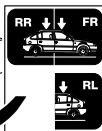
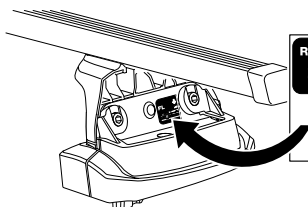

4

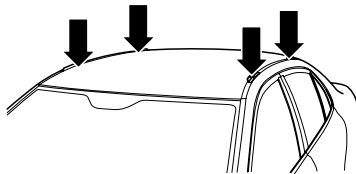
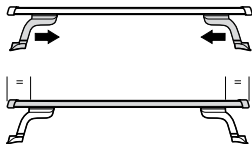
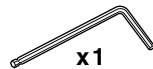
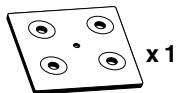
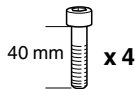

A

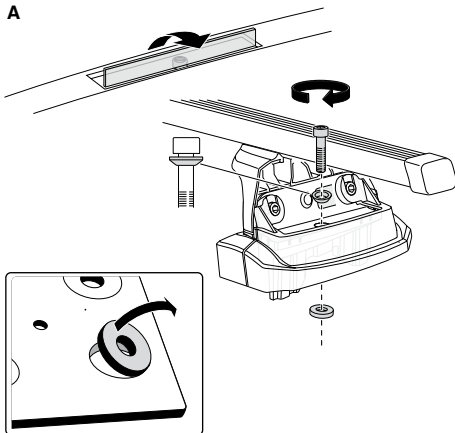

B

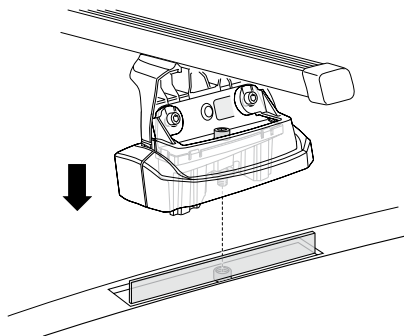

C

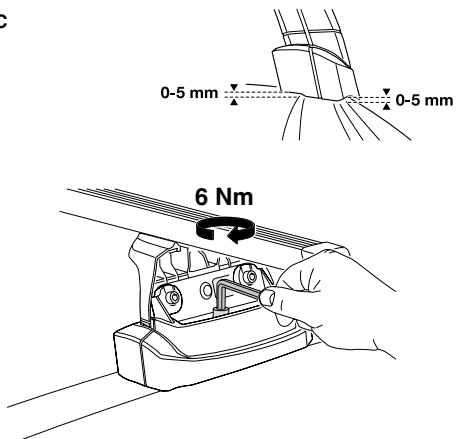

D

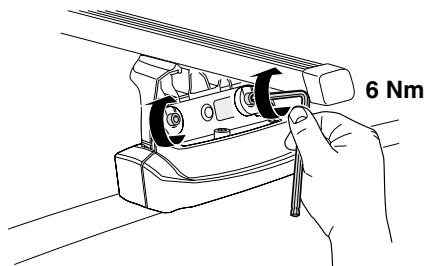

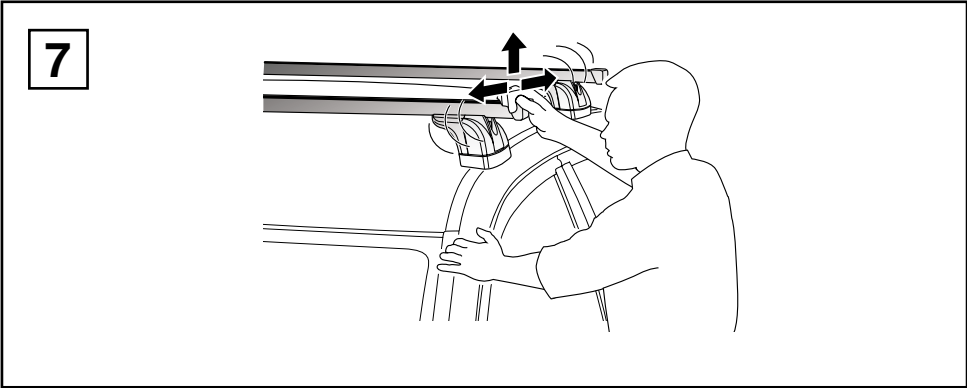
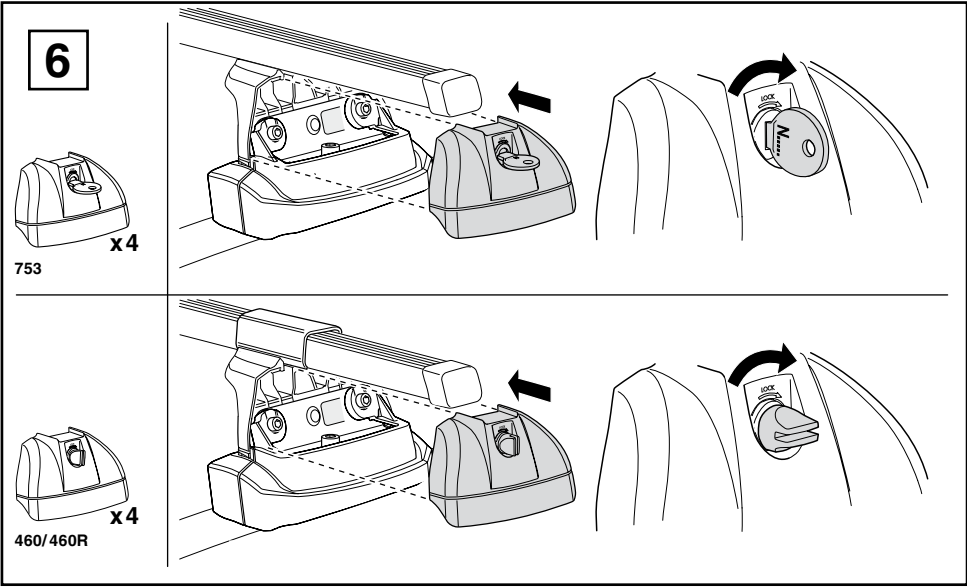
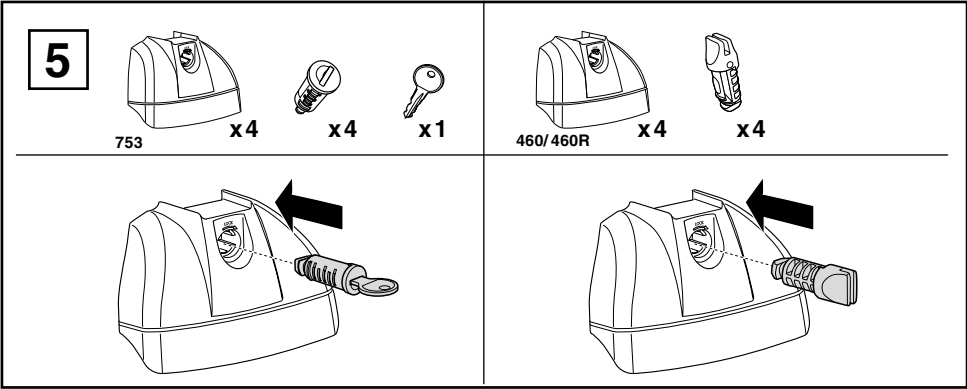

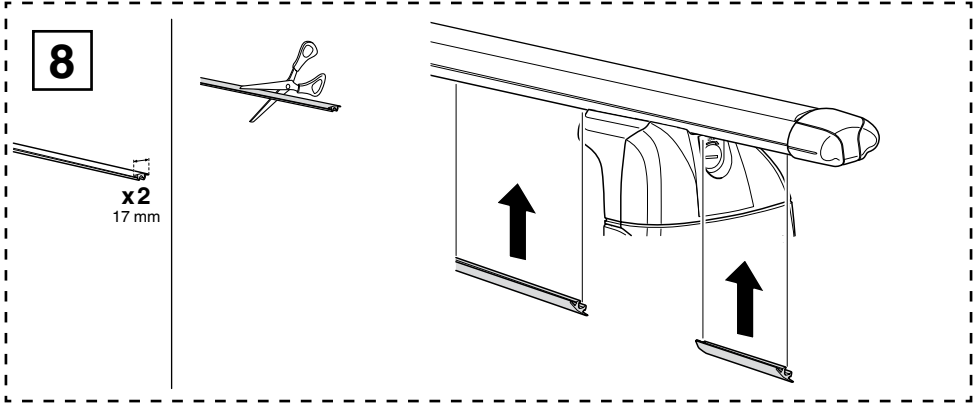

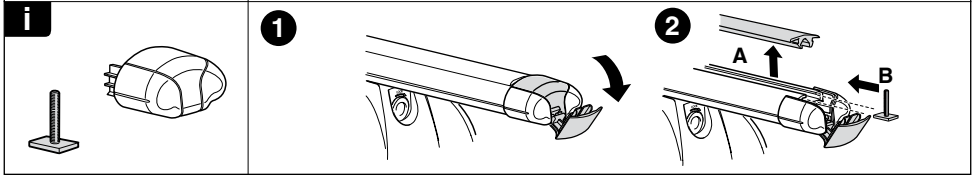
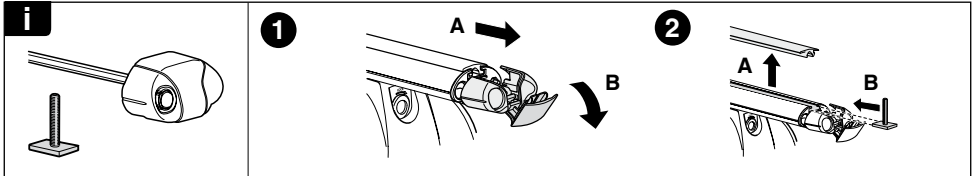
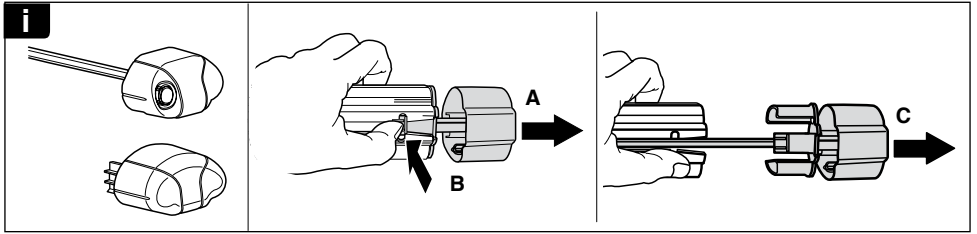



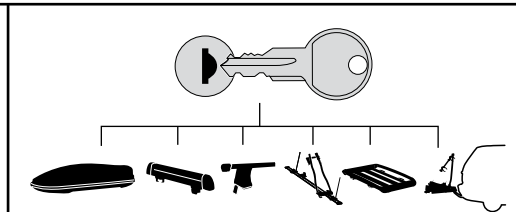





THULE
SWEDEN
**ONE
KEY
SYSTEM**

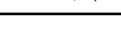

-  **544** (x4)
-  **596** (x6)
-  **588** (x8)
-  **NA 510** (x10)
-  **EUR 452** (x12)
-  **ASIA 452** (x12)

WW ▶ Thule Sweden AB, Box 69, 330 33 Hillerstorp, SWEDEN
NA ▶ Thule Inc., 42 Silvermine Road, Seymour, Connecticut 06483, USA

 info@thule.com
customer.service@thule.com

 www.thule.com