

Kit 3027

GREAT WALL X240, 5-dr SUV, 06–
LAND ROVER Discovery (Mk.III), 5-dr SUV, 04–

This Kit is only for vehicles with T-profile.



460R
753



460

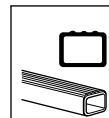

GREAT WALL X240,
5-dr SUV, 06–



Max.
75 kg
Max.
165 lbs

LAND ROVER Discovery (Mk.III),
5-dr SUV, 04–



Max.
100kg
Max.
220 lbs

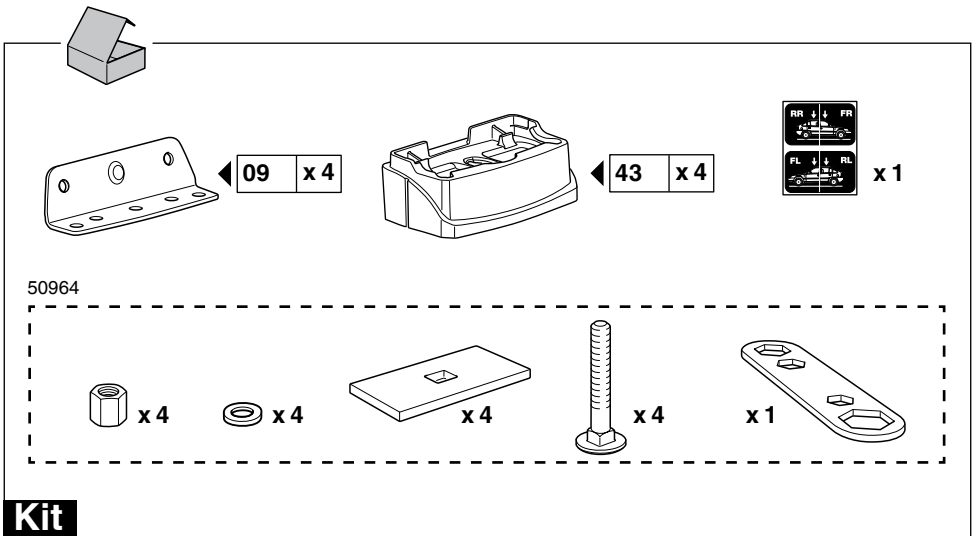
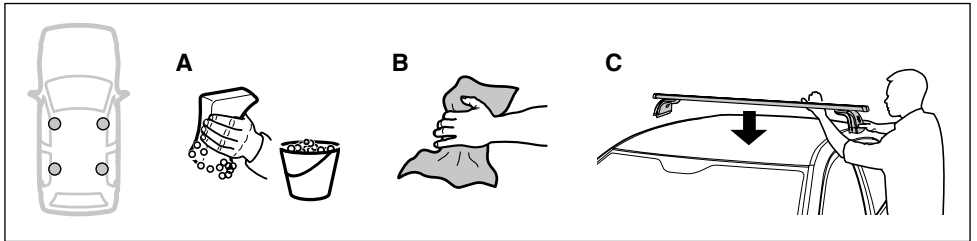
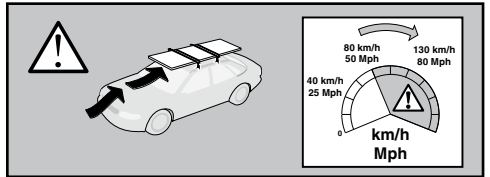
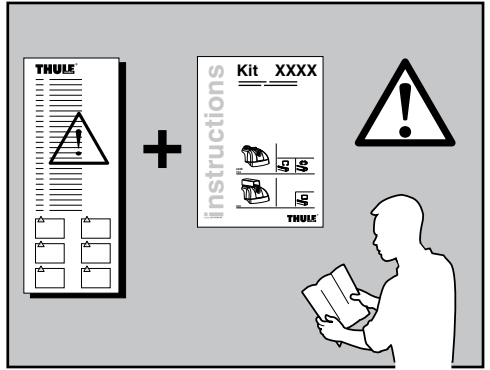

Kit



753



x4



x4



x4



x8

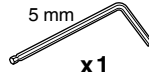

x1



x4



x1

460R



x4



x4



x4



x8

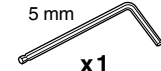

x1



x4

460



x4



x4



x4



x8

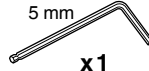

x1



x4

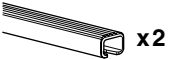
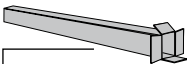

x2



x2

17 mm

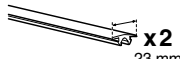

x2

23 mm



x2

23 mm



x2

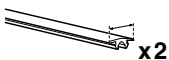

x2

23 mm

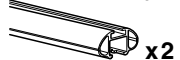

x2



x4

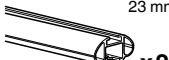

x2



x4



x4

1

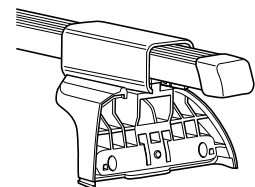
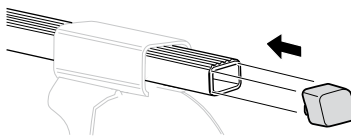
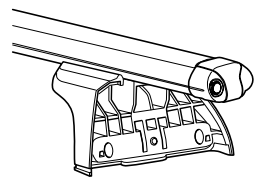
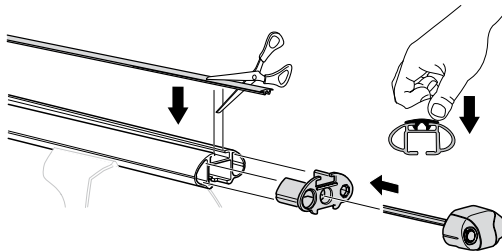
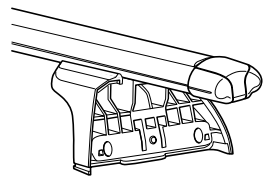
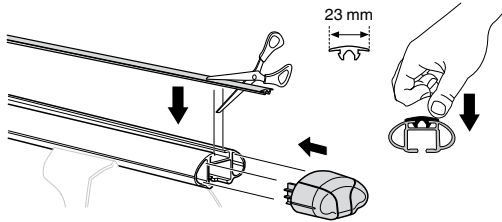
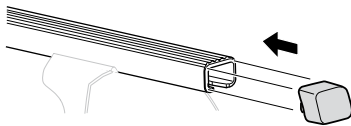

2

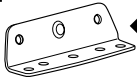

◀ 09 x 4

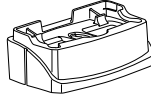

◀ 43 x 4



16 mm x 8



x 1

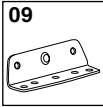

09

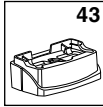

43



FL

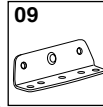
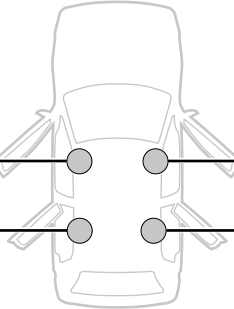

09

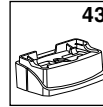

43



FR

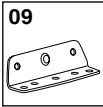

09

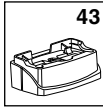

43



RL

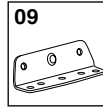

09

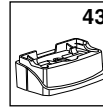

43



RR

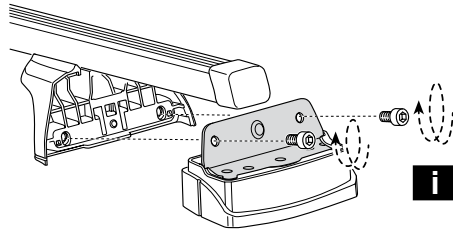
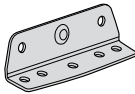

GB Only a few turns
D Nur wenige Umdrehungen
F Quelques tours uniquement
NL Slechts enkele slagen
I Solo qualche giro
E Sólo algunas vueltas
PT Noções básicas
S Endast några varv
FIN Vain muutama kierros

EST Ainult mõni pööre
LAT Tikai dažī apgriezieni
LIT Tik keli pasukimai
PL Wystarczy kilka obrotów
RU Достаточно нескольких оборотов
CZ Pouze několik otáček
SK Len niekoľko otáčok
SLO Le nekaj obratov

HR Samo nekoliko okreta
HU Csak néhány fordítás
GR Μόνο μερικές στροφές
TR Yalnız birkaç kez çevirm
中文 只有几个转向
한국어 두 세번만
日本語 数回転のみ
ไทย หมุนเพียงไม่กี่รอบ

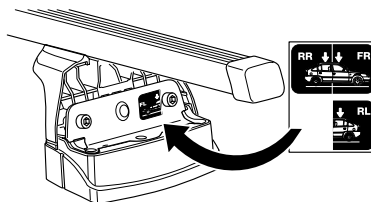

3



x4



x4

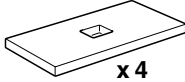

x4

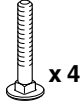

x4

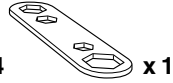

x1

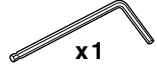

x1

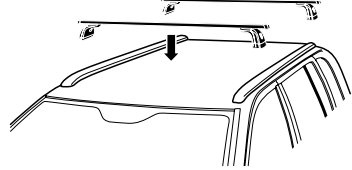
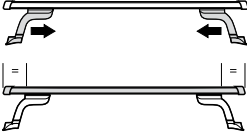

A

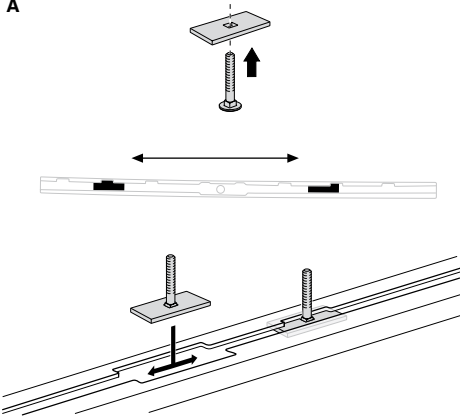

B

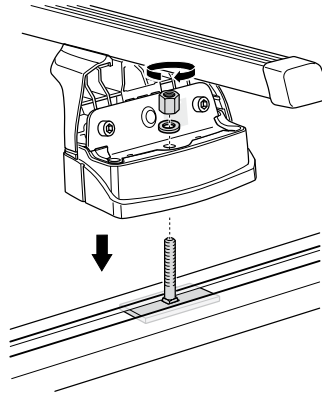

C

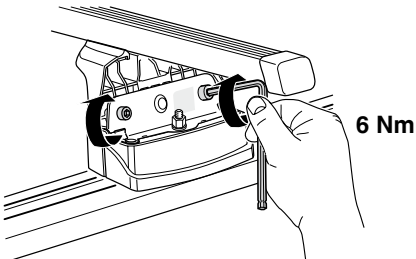

6 Nm

D

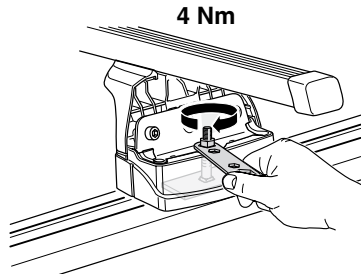

4 Nm

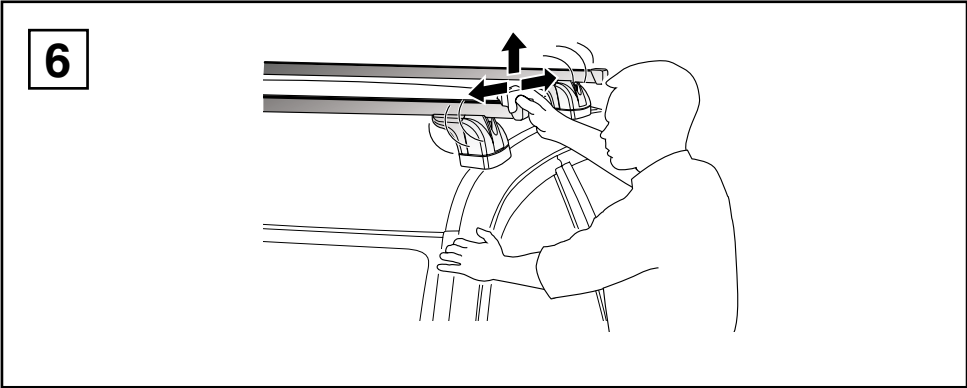
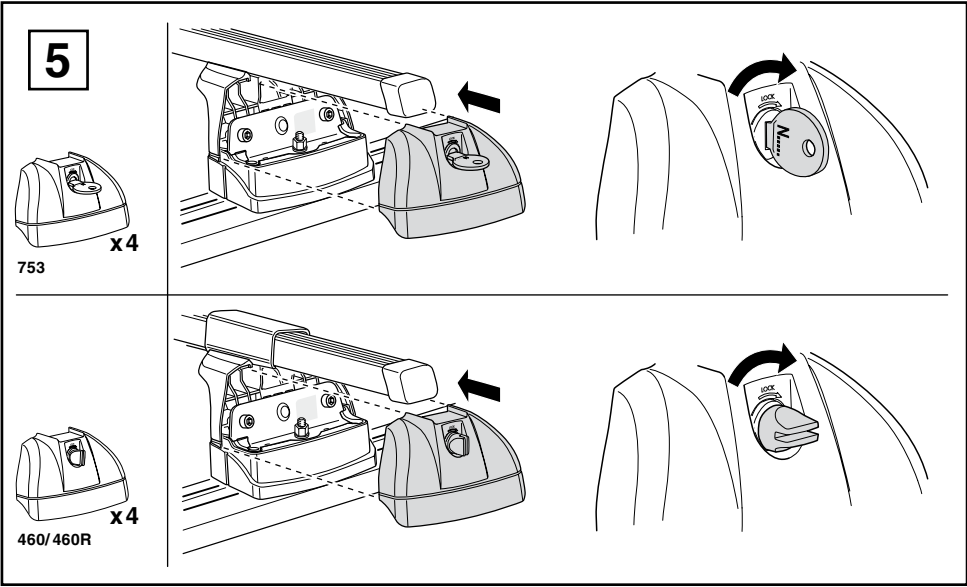
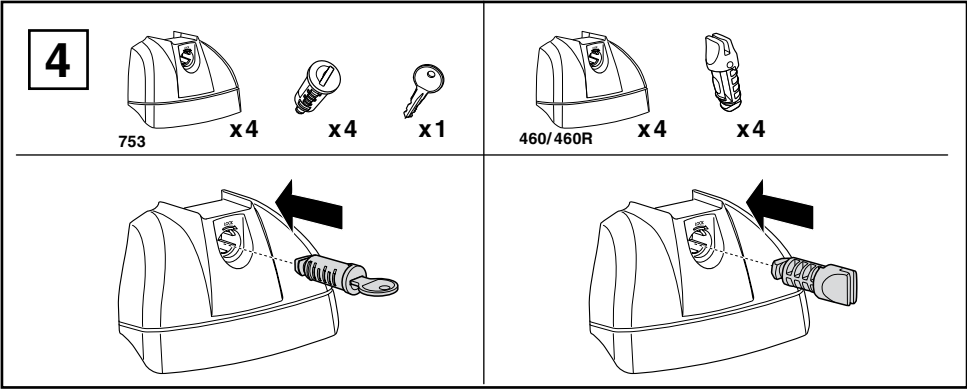

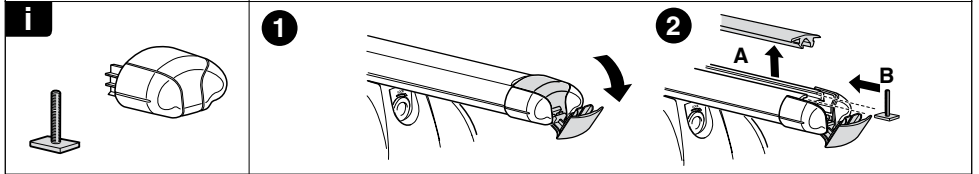
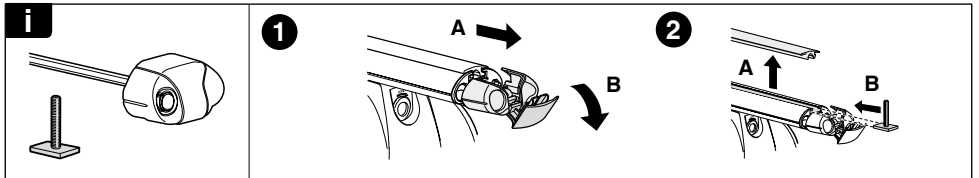
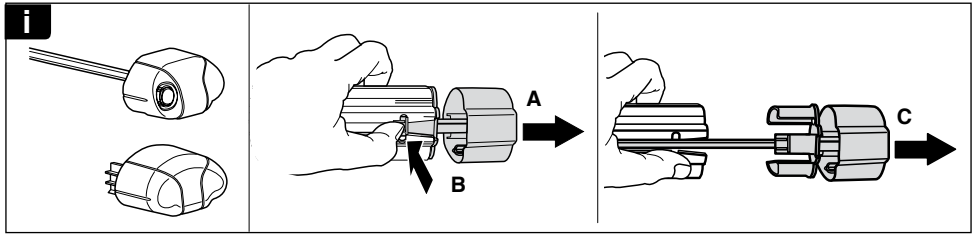
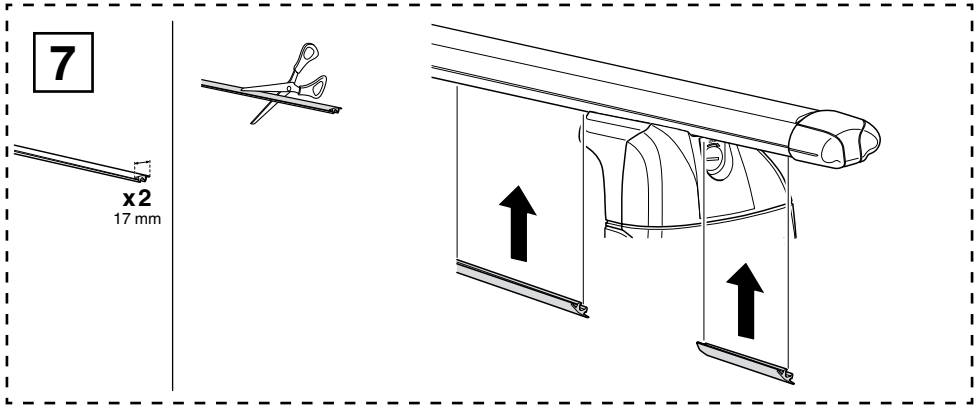

THULE
SWEDEN

**ONE
KEY
SYSTEM**

544 (x4)

596 (x6)

588 (x8)

NA **510** (x10)

EUR **452** (x12)

ASIA **452** (x12)

WW ▶ Thule Sweden AB, Box 69, 330 33 Hillerstorp, SWEDEN

NA ▶ Thule Inc., 42 Silvermine Road, Seymour, Connecticut 06483, USA

info@thule.com
customer.service@thule.com

www.thule.com

506-3027