

# Kit 3032

MERCEDES Sprinter, 4-dr Van, 06-  
VOLKSWAGEN Crafter, 4-dr Van, 06-

This Kit is only for vehicles with fixpoint mounting.



460R  
753

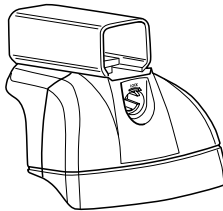
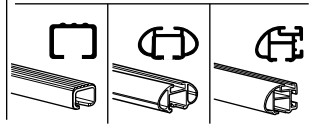

460

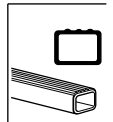

6 kg / 13 lbs + xx kg xx lbs =
   
**Max. 100 kg**
  
**Max. 220 lbs**

9 kg / 20 lbs + xx kg xx lbs =
   
**Max. 150 kg**
  
**Max. 330 lbs**

12 kg / 26 lbs + xx kg xx lbs =
   
**Max. 200 kg**
  
**Max. 440 lbs**

50979

**Kit**



753



x4



x4



x4



x8

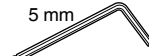

x1



x4



x1

460R



x4



x4



x4



x8

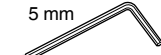

x1



x4

460



x4



x4



x4



x8

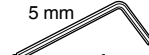

x1



x4



x2



x2

17 mm



x2

23 mm



x2

23 mm



x2



x2

17 mm

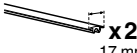

x2

23 mm

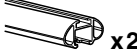

x2

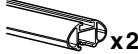

x2

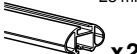

x2



x4

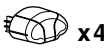

x4



x4

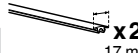

x2

25 mm

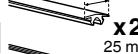

x2



x2

x2

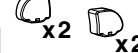

x4

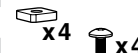

x4



x1

5 mm

1

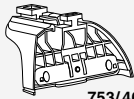

753/460R

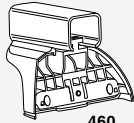

460

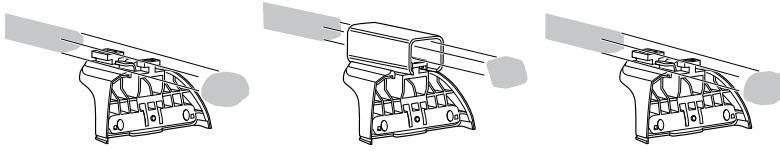

x4

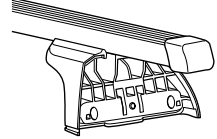
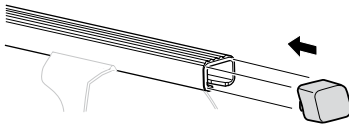

x4

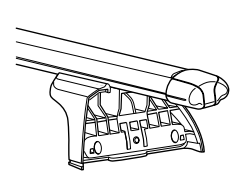
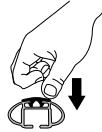
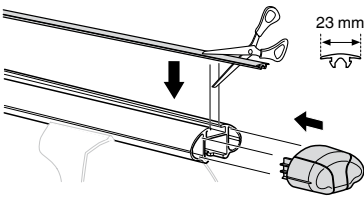

x4

x4

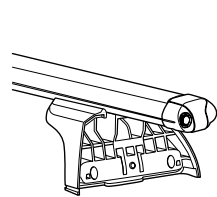
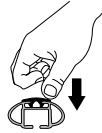
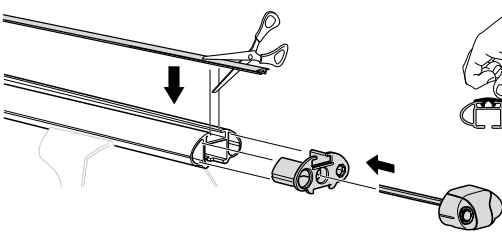

x4

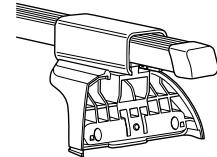
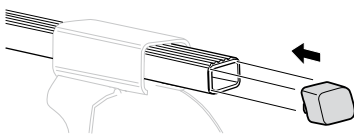

x2

x2

x4

x4

x1  
5 mm

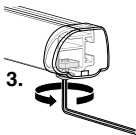
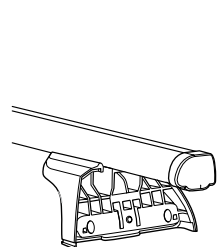
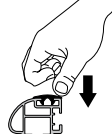
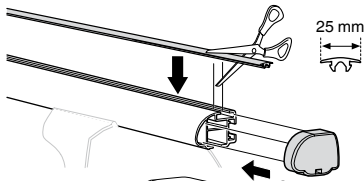

2

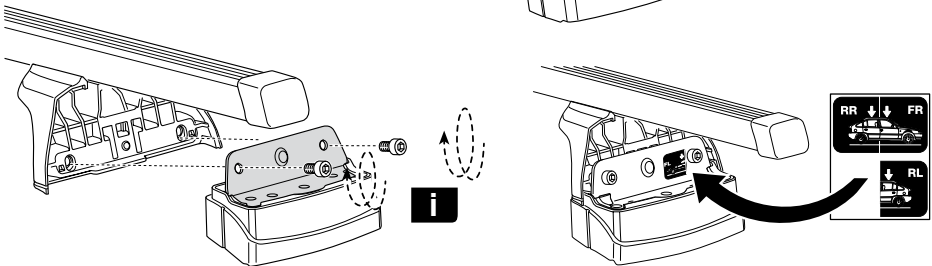
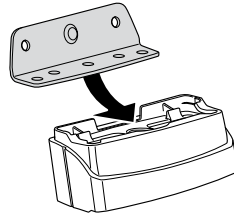
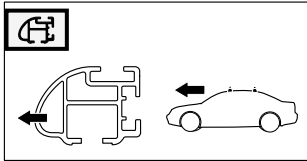
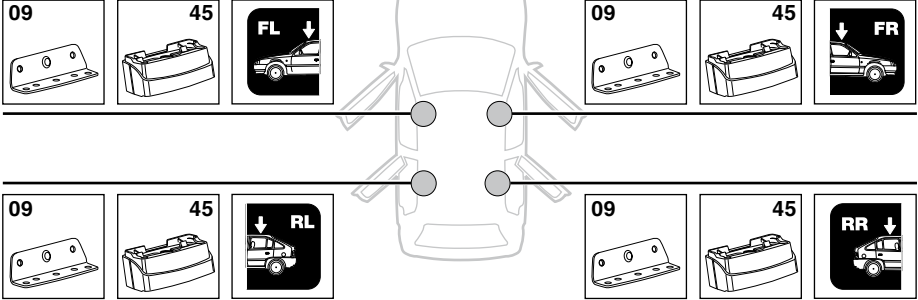

<b>i</b>	<b>GB</b> Only a few turns	<b>EST</b> Ainult mõni pööre	<b>HR</b> Samo nekoliko okreta
	<b>D</b> Nur wenige Umdrehungen	<b>LAT</b> Tikai dažī apgriezieni	<b>HU</b> Csak néhány fordítás
	<b>F</b> Quelques tours uniquement	<b>LIT</b> Tik keli pasukimai	<b>GR</b> Μόνο μερικές στροφές
	<b>NL</b> Slechts enkele slagen	<b>PL</b> Wystarczy kilka obrotów	<b>TR</b> Yalnız birkaç kez çevirm
	<b>I</b> Solo qualche giro	<b>RU</b> Достаточно нескольких оборотов	<b>中文</b> 只有几个转向
	<b>E</b> Sólo algunas vueltas	<b>SK</b> Len niekoľko otáčok	<b>한국어</b> 두 세번만
	<b>PT</b> Noções básicas	<b>CZ</b> Pouze několik otáček	<b>日本語</b> 数回転のみ
	<b>S</b> Endast några varv	<b>SK</b> Len niekoľko otáčok	<b>ไทย</b> หมุนเพียงไม่กี่รอบ
	<b>FIN</b> Vain muutama kierros	<b>SLO</b> Le nekaj obratov	

**3**



x4



x4



x4



x4

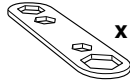

x1

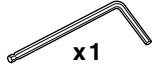

x1

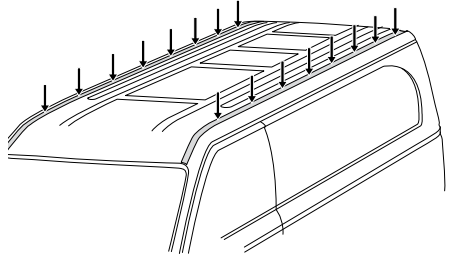
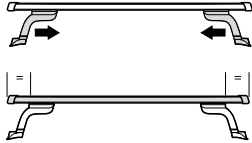

**A**

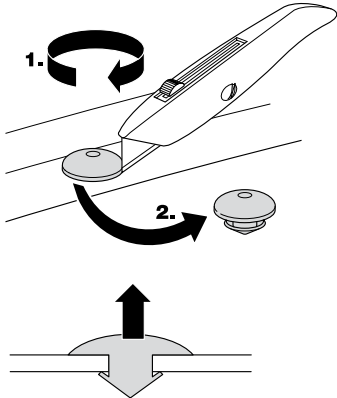

**B**

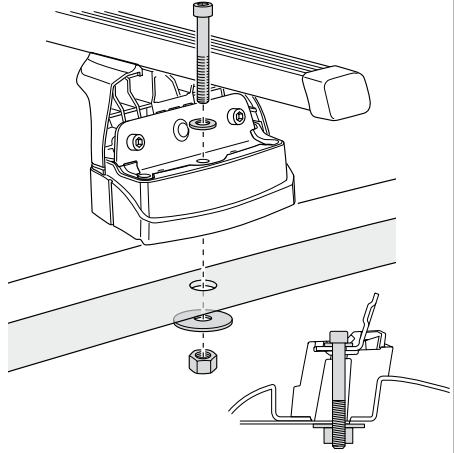

**C**

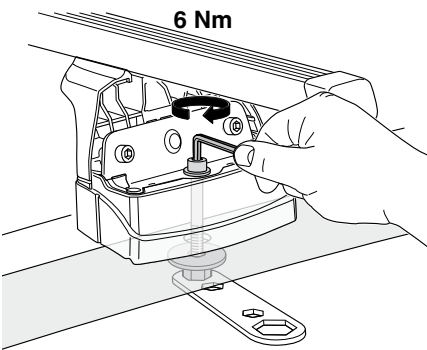

6 Nm

**D**

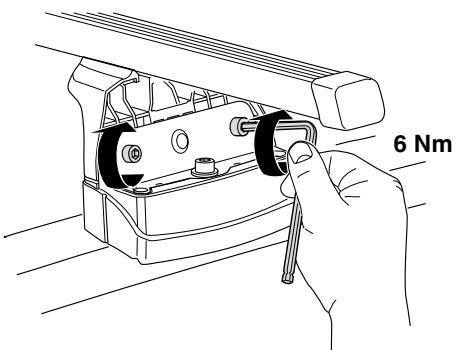

6 Nm

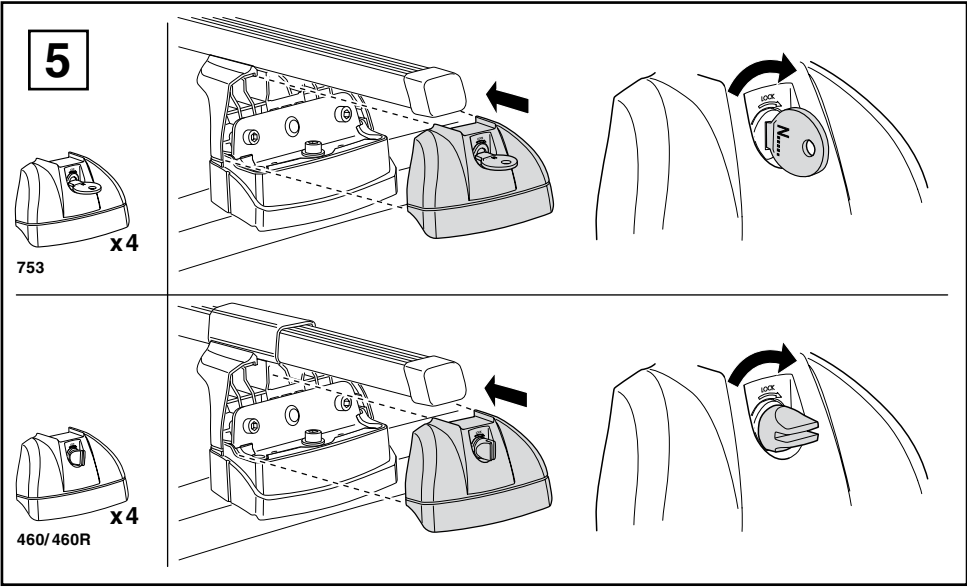
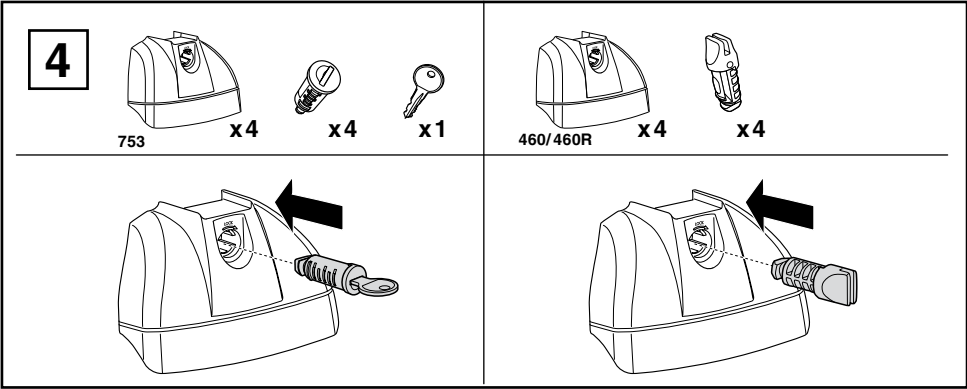

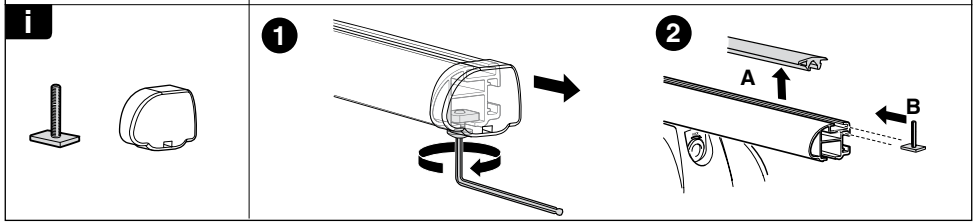
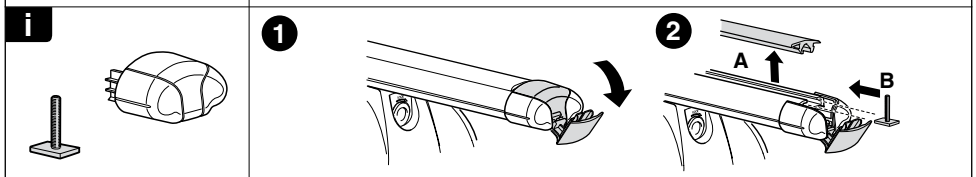
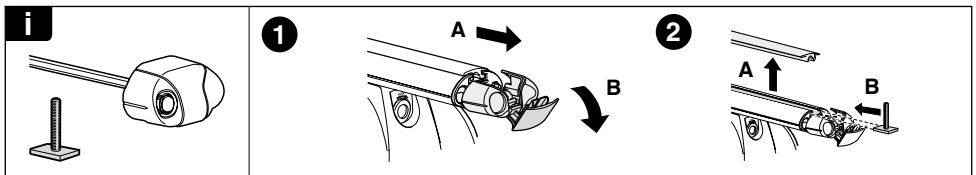
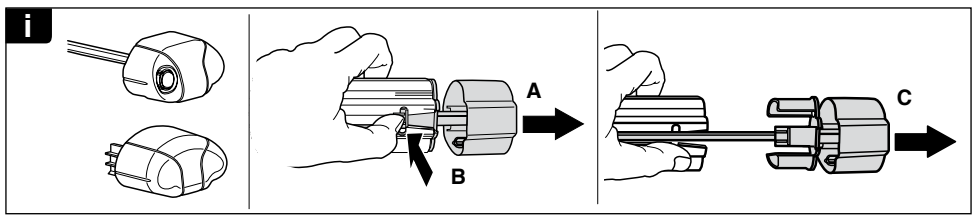
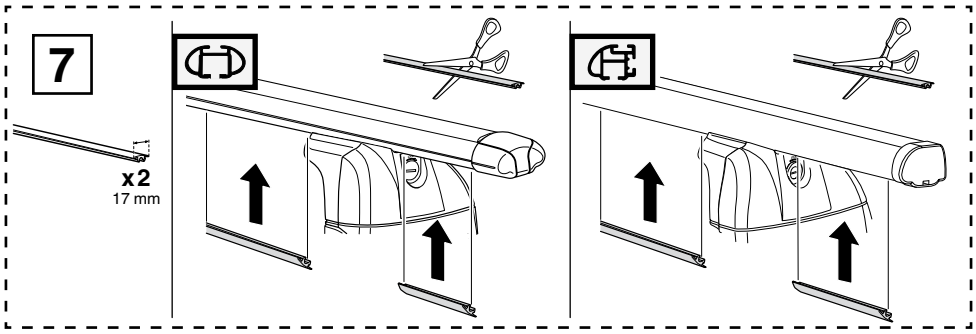

**THULE**  
SWEDEN  
**ONE  
KEY  
SYSTEM**

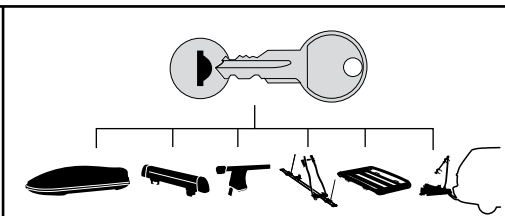

- 544 (x4)
  - 596 (x6)
  - 588 (x8)
  - 510 (x10)
  - 452 (x12)
- NA  
EUR  
ASIA