

# Kit 3033

FORD Galaxy, 5-dr MPV, 06–

FORD Focus II, 5-dr MPV, 04–

MERCEDES Viano Marco Polo, 5-dr MPV, 03–

This Kit is only for vehicles with T-profile.

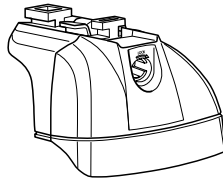

460R  
753

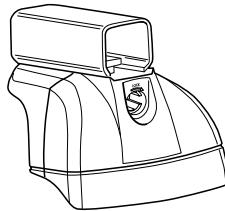

460

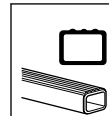

6 kg / 13 lbs + xx kg / xx lbs =

**Max. 75kg**  
**Max. 165 lbs**

9 kg / 20 lbs + xx kg / xx lbs =

**Max. 100 kg**  
**Max. 220 lbs**

12 kg / 26 lbs + xx kg / xx lbs =

**Max. 150 kg**  
**Max. 330 lbs**

THULE Kit XXXX

80 km/h 130 km/h  
50 Mph 80 Mph  
40 km/h 25 Mph

**km/h**  
**Mph**

**A** **B** **C**

09 x 4      43 x 4      x 1

50942

x 4      x 4      x 4      x 4      x 1

**Kit**

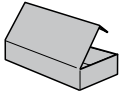

753

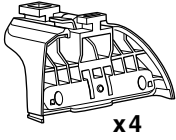

x4



x4



x4



x8

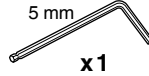

x1



x4



x1

460R

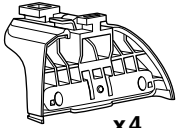

x4



x4



x4



x8

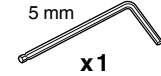

x1



x4

460

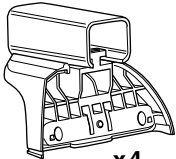

x4



x4



x4



x8

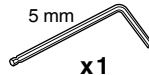

x1



x4

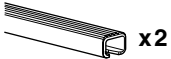
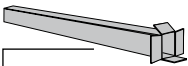

x2



x2

17 mm

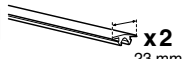

x2

23 mm



x2

23 mm

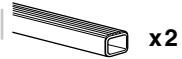

x2

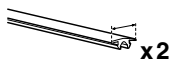

x2

23 mm

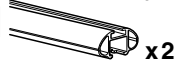

x2

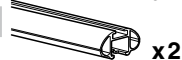

x2

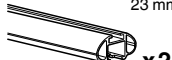

x2



x4



x4



x4

1

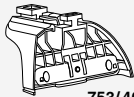

753/460R

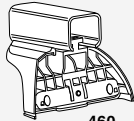

460

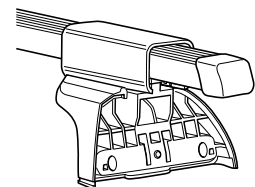
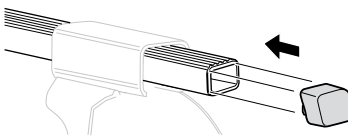
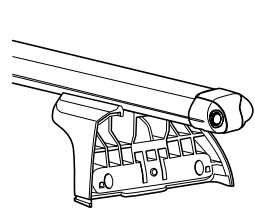
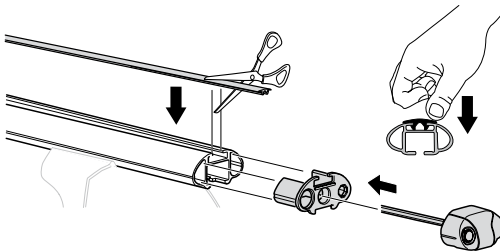
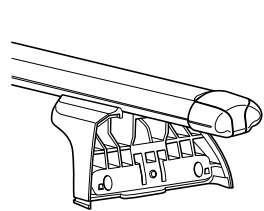
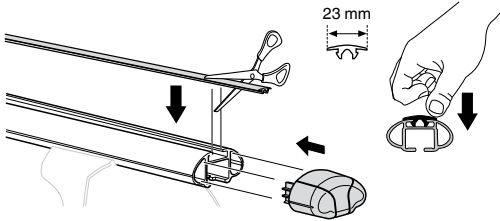
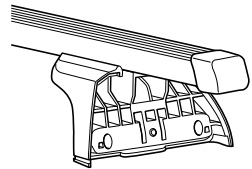
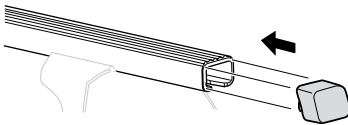
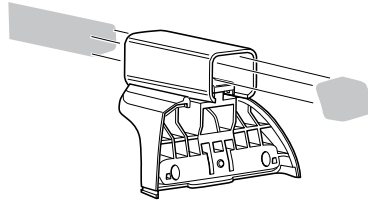
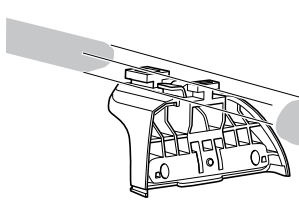

2

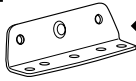

◀ 09 x 4

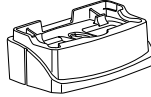

◀ 43 x 4



16 mm x 8



x 1

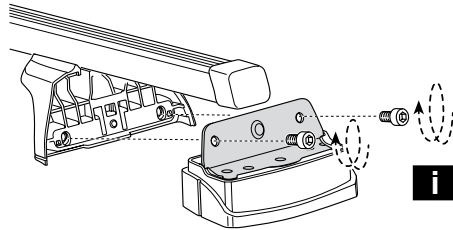
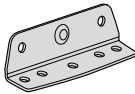
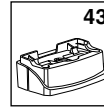
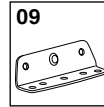
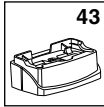
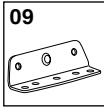
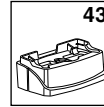
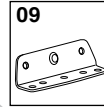
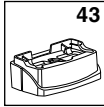
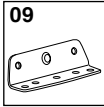

- GB** Only a few turns
- D** Nur wenige Umdrehungen
- F** Quelques tours uniquement
- NL** Slechts enkele slagen
- I** Solo qualche giro
- E** Sólo algunas vueltas
- PT** Noções básicas
- S** Endast några varv
- FIN** Vain muutama kierros

- EST** Ainult mõni pööre
- LAT** Tikai dažī apgriezieni
- LIT** Tik keli pasukimai
- PL** Wystarczy kilka obrotów
- RU** Достаточно нескольких оборотов
- CZ** Pouze několik otáčecí
- SK** Len niekoľko otáčok
- SLO** Le nekaj obratov

- HR** Samo nekoliko okreta
- HU** Csak néhány fordítás
- GR** Μόνο μερικές στροφές
- TR** Yalnız birkaç kez çevirm
- 中文** 只有几个转向
- 한국어** 두 세번만
- 日本語** 数回転のみ
- ไทย** หมุนเพียงไม่กี่รอบ

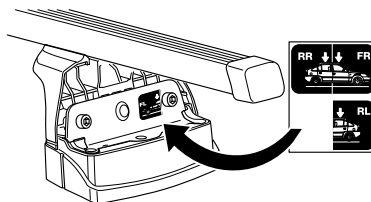

**3**

x4



x4

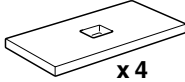

x4

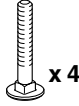

x4

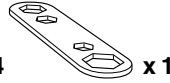

x1

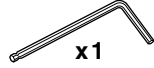

x1

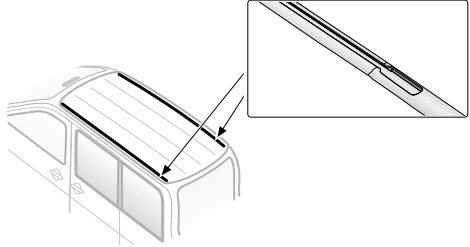
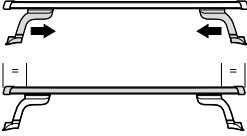

A

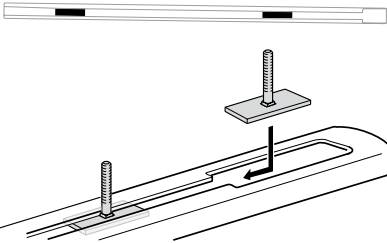
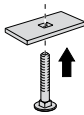
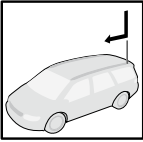

B

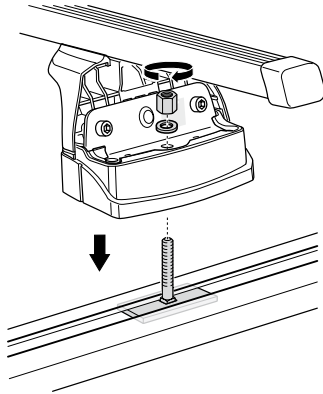

C

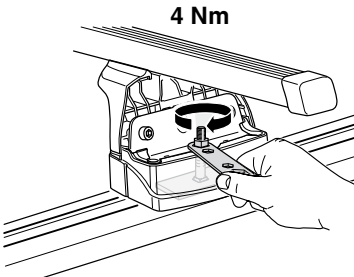

4 Nm

D

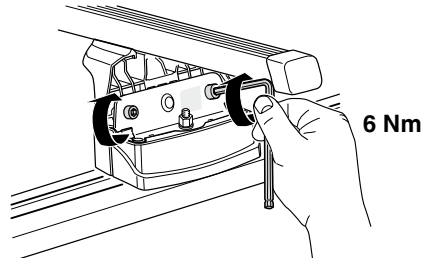

6 Nm

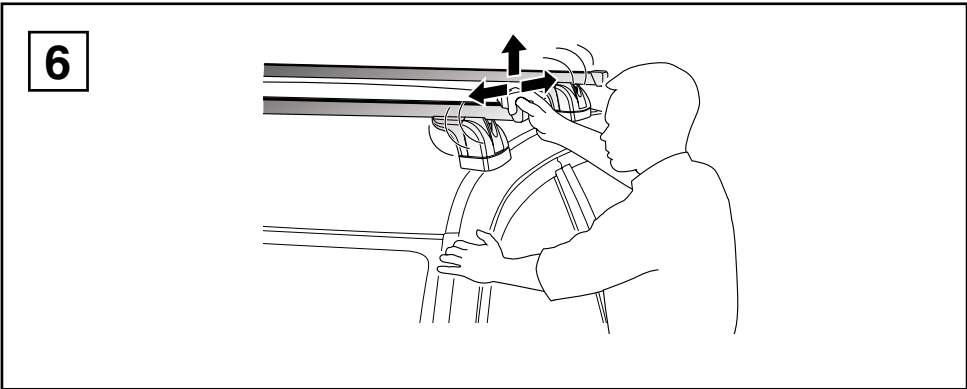
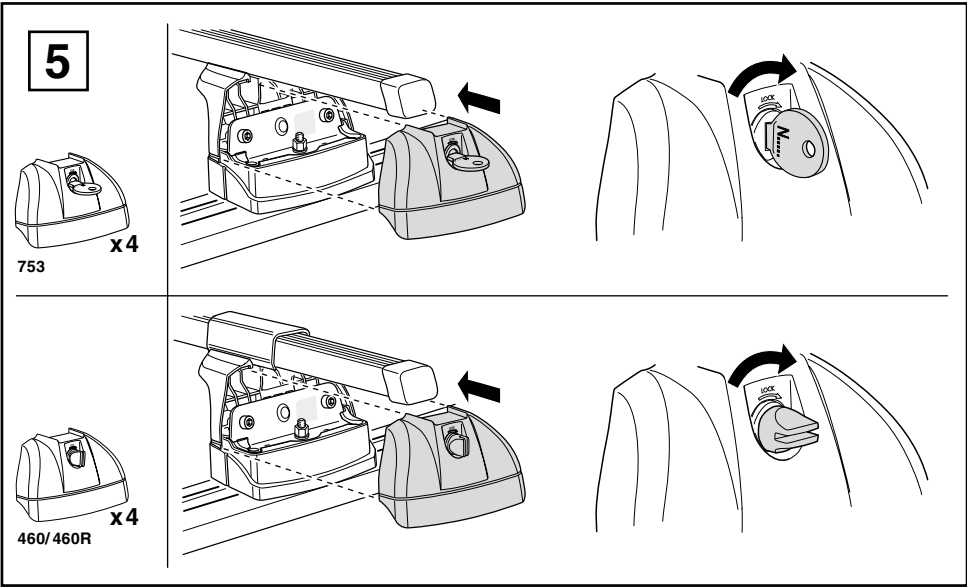
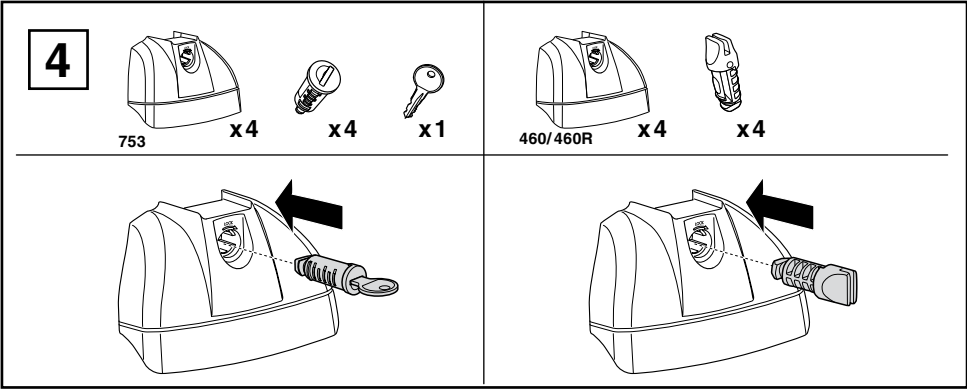

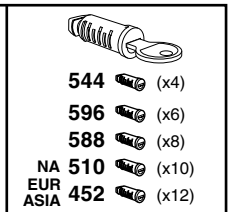
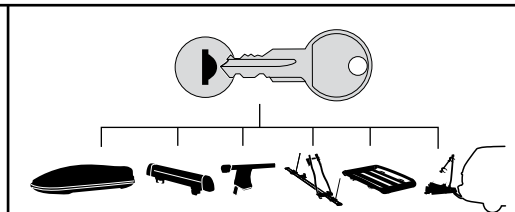
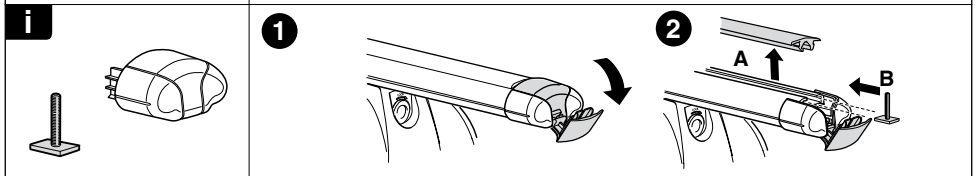
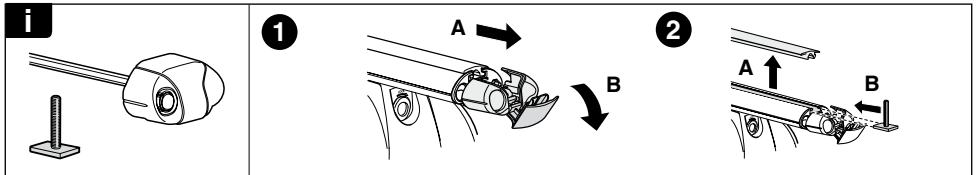
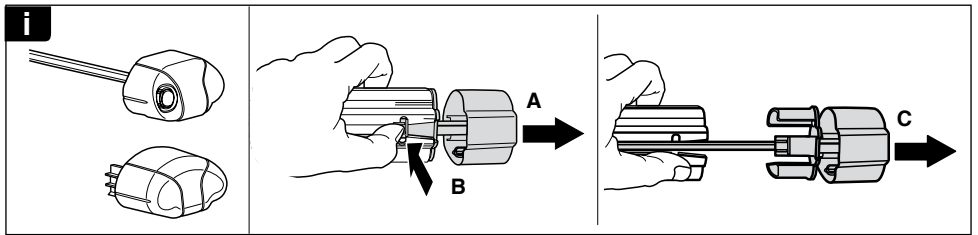
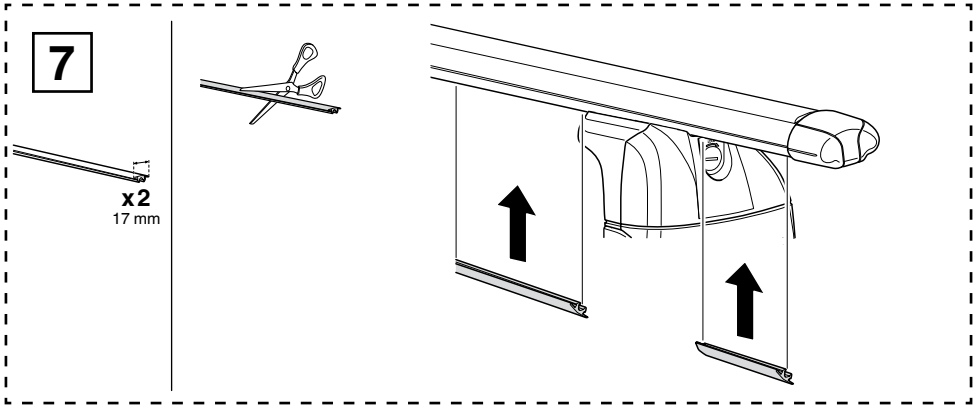

**WW** ▶ Thule Sweden AB, Box 69, 330 33 Hillerstorp, SWEDEN

**NA** ▶ Thule Inc., 42 Silvermine Road, Seymour, Connecticut 06483, USA

**@** info@thule.com  
customer.service@thule.com

**www.thule.com**