

Kit 3047

NISSAN Primastar, 4/5-dr Van, 02-06, 07-

OPEL Vivaro, 2-dr Singel cab, 01-06, 07-

OPEL Vivaro, 4/5-dr Van, 01-06, 07-

RENAULT Trafic, 2-dr Singel cab, 01-06

RENAULT Trafic, 4/5-dr Van, 01-06, 07-

This Kit is only for vehicles with fixpoint mounting.

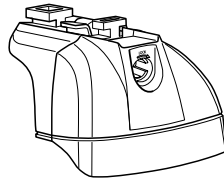

460R
753

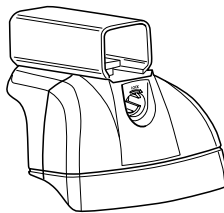
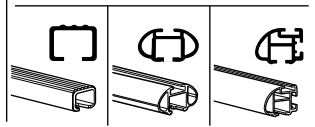

460

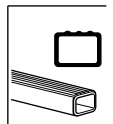

6 kg / 13 lbs + xx kg xx lbs =

Max. 100 kg

Max. 220 lbs

9 kg / 20 lbs + xx kg xx lbs =

Max. 150 kg

Max. 330 lbs

12 kg / 26 lbs + xx kg xx lbs =

Max. 200 kg

Max. 440 lbs

A

B

C

50946

Kit



753

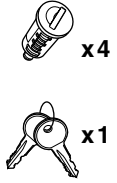
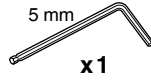
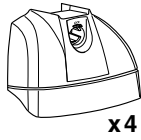

460R

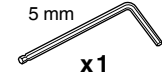
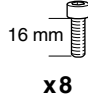
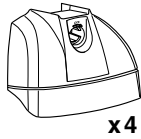
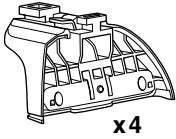

460

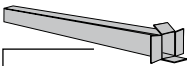
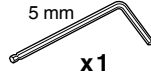
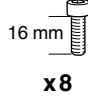
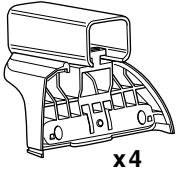

x2



x2
17 mm



x2
23 mm



x2
23 mm



x2



x2
17 mm

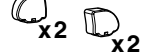
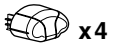
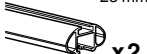
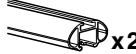
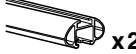
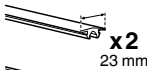

1



753/460R

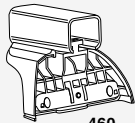

460

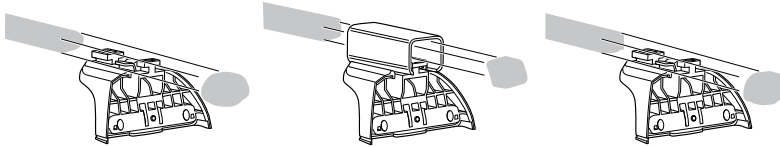

x4

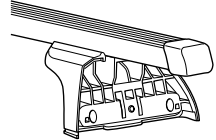
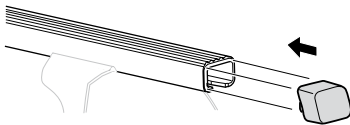

x4

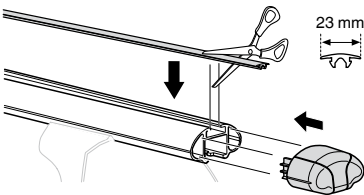

23 mm

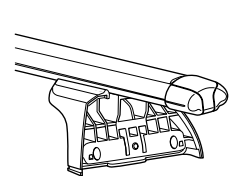
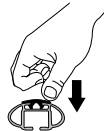

x4

x4

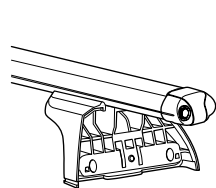
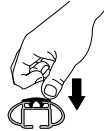
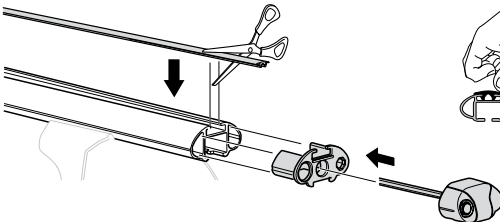

x4

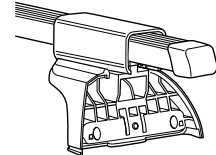
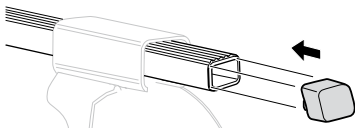

x2

x2

x4

x4

x1
5 mm

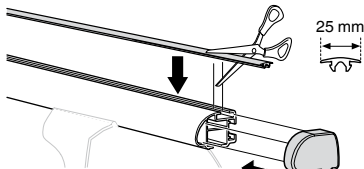

25 mm

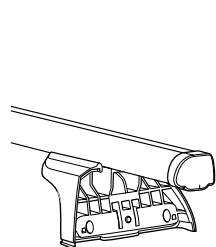
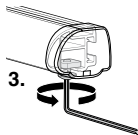
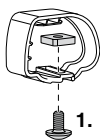
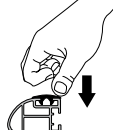

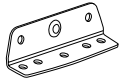
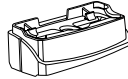
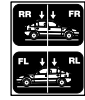
2**04** x 4**61** x 116 mm  x 8

x 1

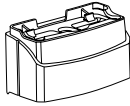
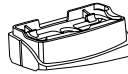
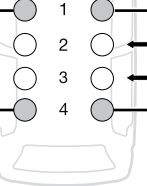
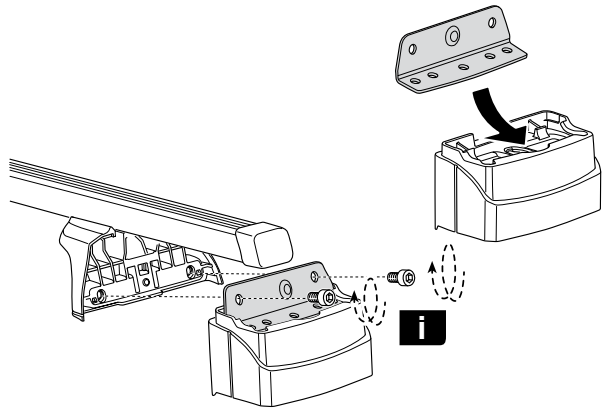
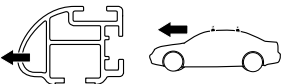
**60** x 2**62** x 1**04****62****04****61****Kit 3046****Kit 3046****04****60****04****06****i**

- GB** Only a few turns
D Nur wenige Umdrehungen
F Quelques tours uniquement
NL Slechts enkele slagen
I Solo qualche giro
E Sólo algunas vueltas
PT Noções básicas
S Endast några varv
FIN Vain muutama kierros
EST Ainult mõni pööre
LAT Tikai dažī apgriezieni
LIT Tik keli pasukimai
PL Wystarczy kilka obrotów
RU Достаточно нескольких оборотов
CZ Pouze několik otáček
SK Len niekoľko otáčok
SLO Le nekaj obratov

- HR** Samo nekoliko okreta
HU Csak néhány fordítás
GR Μόνο μερικές στροφές
TR Yalnız birkaç kez çevirm
中文 只有几个转向
한국어 두 세번만
日本語 数回転のみ
ไทย หมุนเพียงไม่กี่รอบ

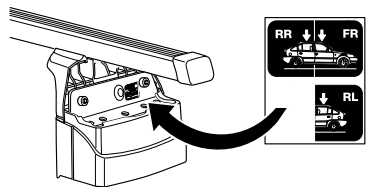

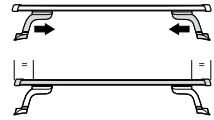
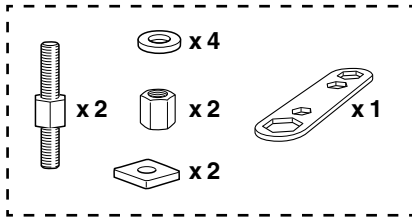
3**NISSAN Primastar,**

4/5-dr Van, 02-06, 07-

OPEL Vivaro,

2-dr Singel cab, 01-06, 07-

OPEL Vivaro,

4/5-dr Van, 01-06, 07-

RENAULT Trafic,

2-dr Singel cab, 01-06

RENAULT Trafic,

4/5-dr Van, 01-06, 07-

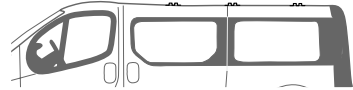
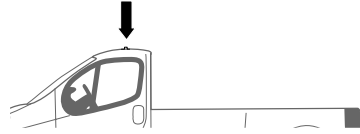
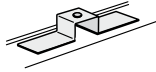
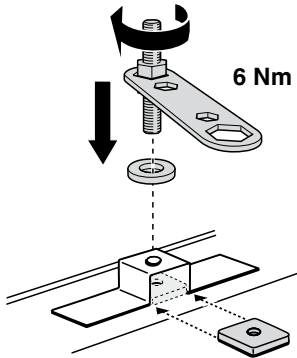
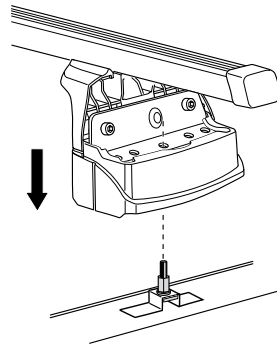
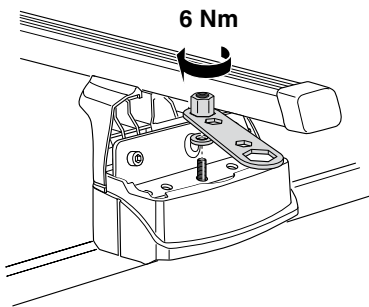
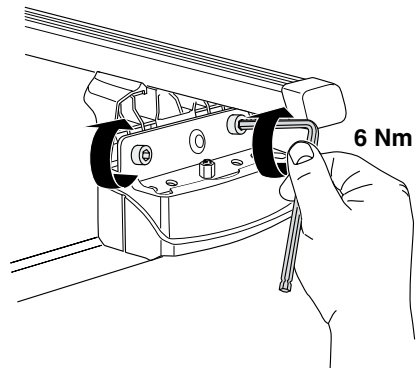
**A****B****C****D**

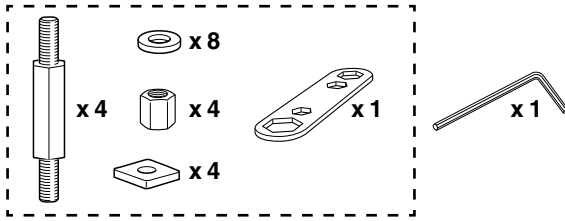
3**NISSAN Primastar,**

4/5-dr Van, 02-06, 07-

OPEL Vivaro,

4/5-dr Van, 01-06, 07-

RENAULT Trafic,

4/5-dr Van, 01-06, 07-

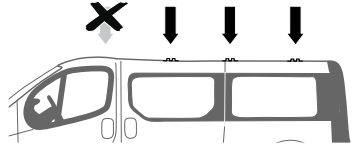
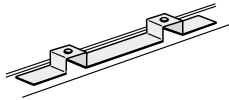
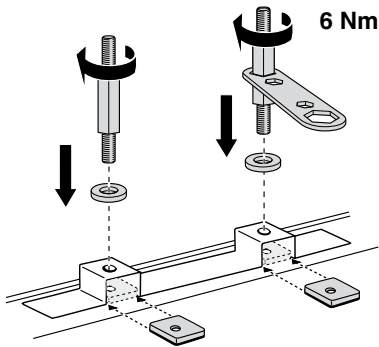
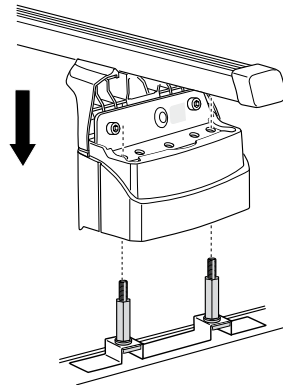
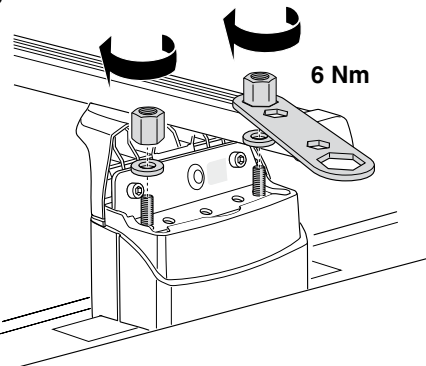
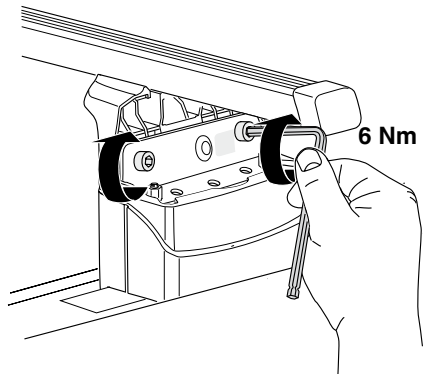
**A****B****C****D**

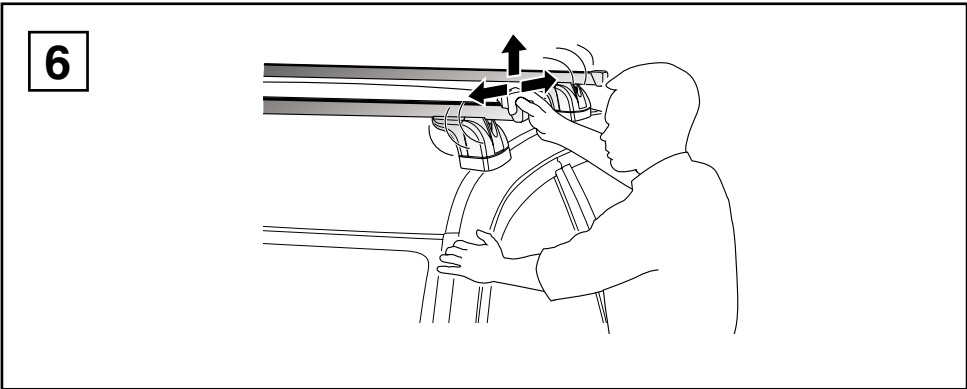
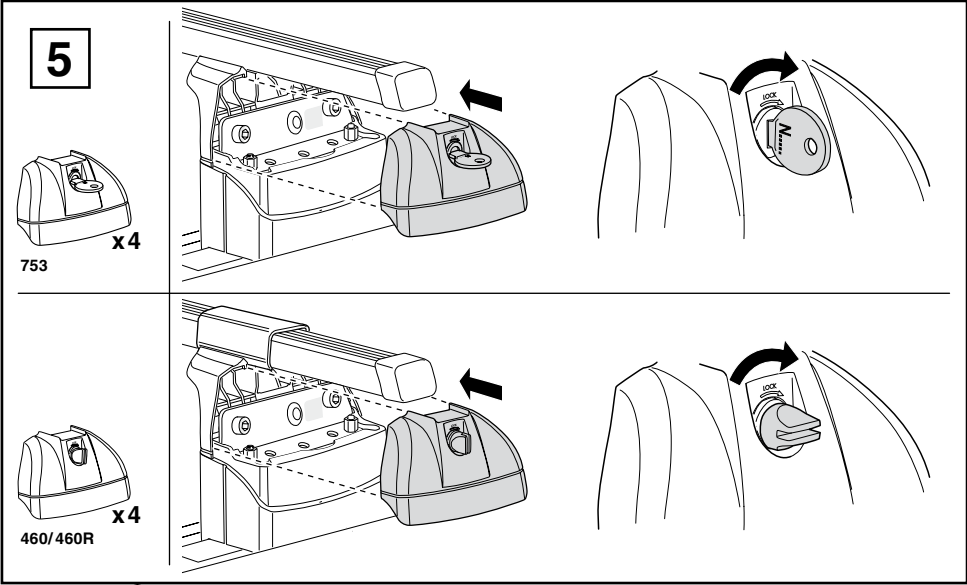
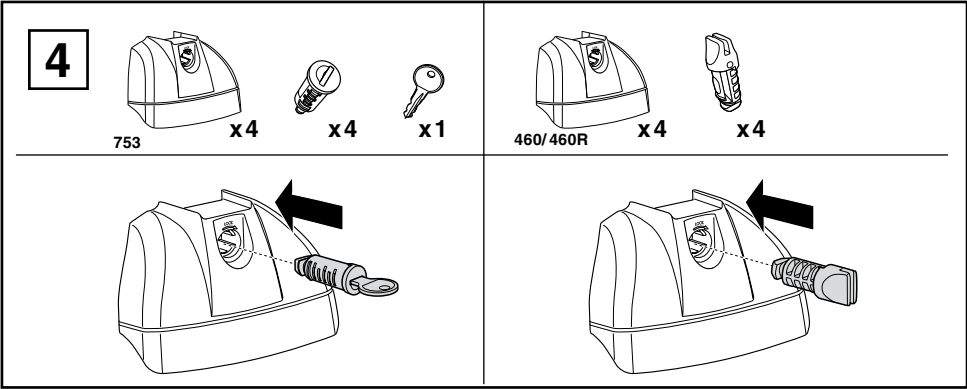

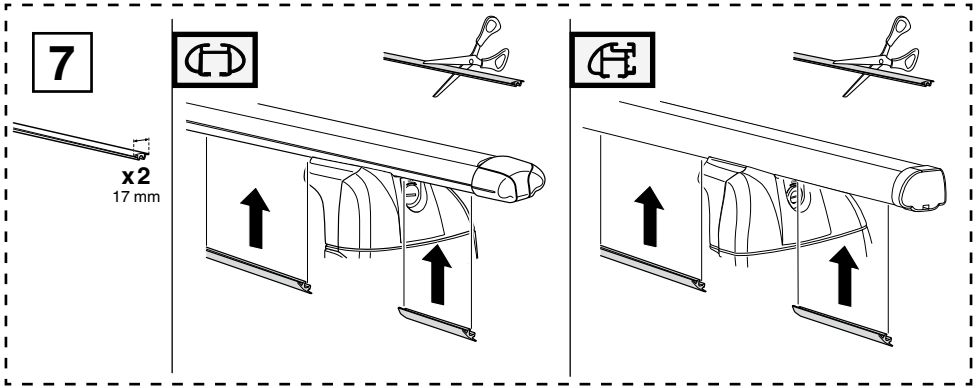

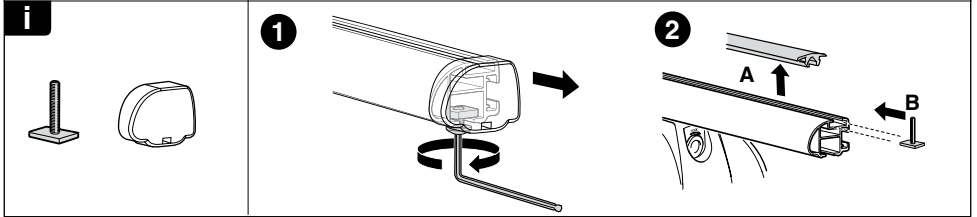
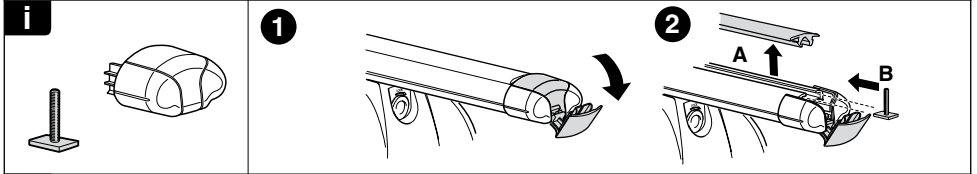
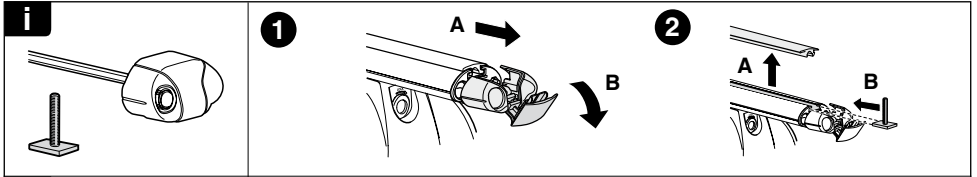
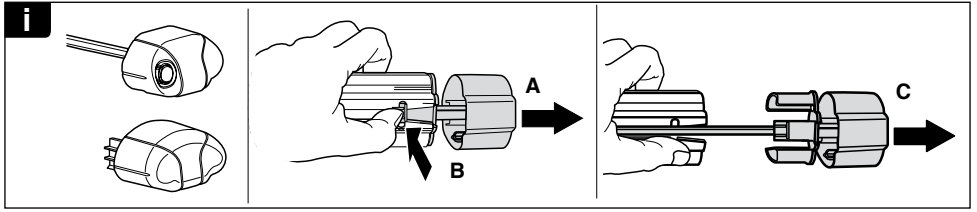



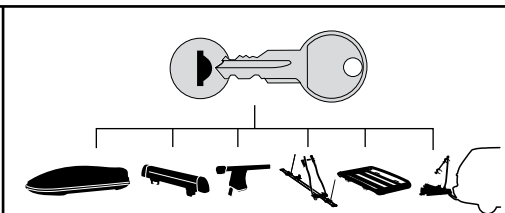

THULE
SWEDEN
**ONE
KEY
SYSTEM**



-  **544** (x4)
 -  **596** (x6)
 -  **588** (x8)
 -  **510** (x10)
 -  **452** (x12)
- NA
EUR
ASIA