

Kit 3049

MERCEDES C-class (W204), 4-dr Sedan, 04- / *07-
MERCEDES E-class (W212), 4-dr Sedan, 09- / *10-
*North America

This Kit is only for vehicles with fixpoint and without glassroof.



460R
753

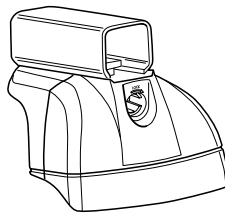
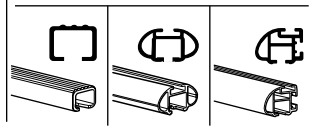

460

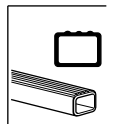

Kit

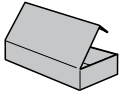

753

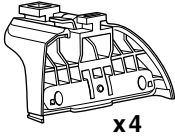

x4



x4



x4



x8

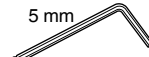

x1



x4



x1

460R

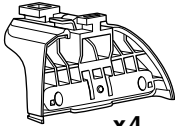

x4



x4



x4



x8



x1



x4

460

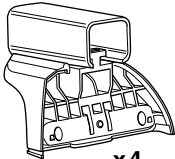

x4



x4



x4



x8

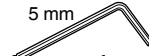

x1



x4



x2



x2



x2



x2



x2



x2



x2

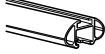

x2

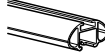

x2

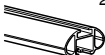

x2



x4

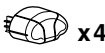

x4



x4

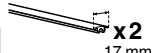

x2



x2



x2



x2



x2



x4



x4



x1

1

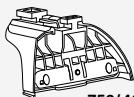

753/460R



460

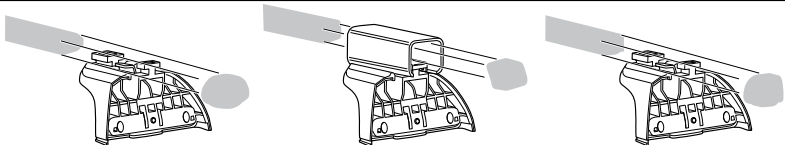

x4

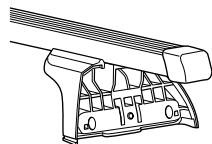
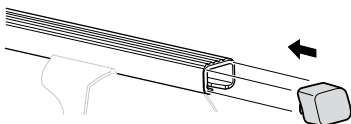

x4

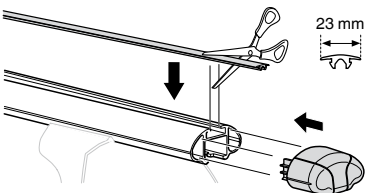

23 mm

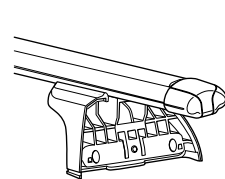
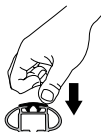

x4

x4

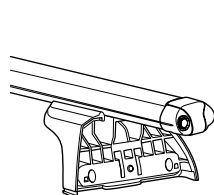
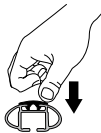
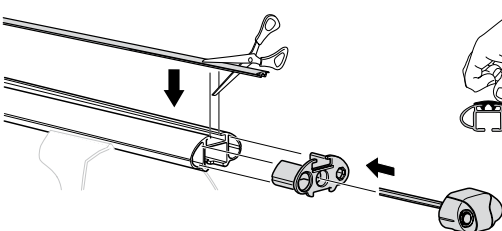

x4

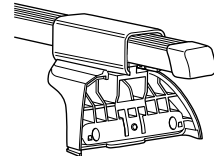
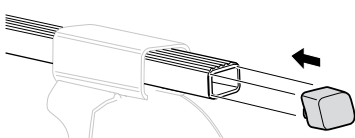

x2

x2

x4

x4

x1
5 mm

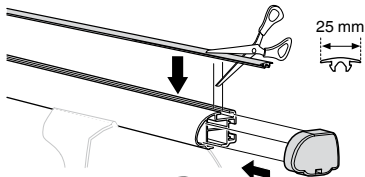

25 mm

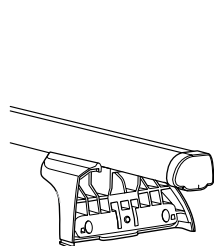
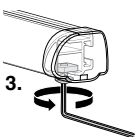
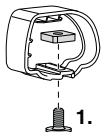
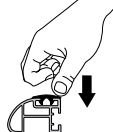

2

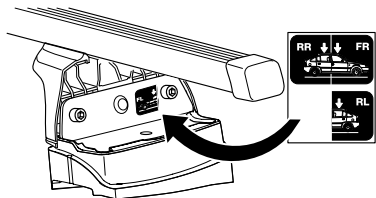
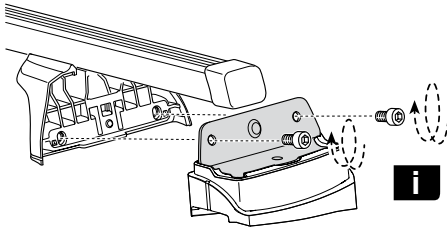
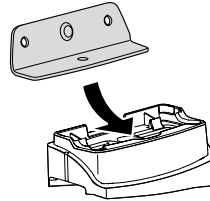
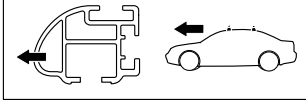
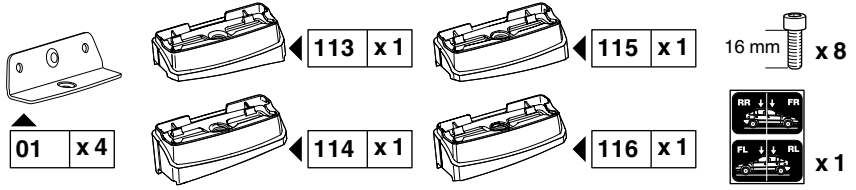

- | | | | | | |
|------------|---------------------------|------------|--------------------------------|------------|--------------------------|
| GB | Only a few turns | EST | Ainult mõni pööre | HR | Samo nekoliko okreta |
| D | Nur wenige Umdrehungen | LAT | Tikai dažī apgriezieni | HU | Csak néhány fordítás |
| F | Quelques tours uniquement | LIT | Tik keli pasukimai | GR | Μόνο μερικές στροφές |
| NL | Slechts enkele slagen | PL | Wystarczy kilka obrotów | TR | Yalnız birkaç kez çevirm |
| I | Solo qualche giro | RU | Достаточно нескольких оборотов | 中文 | 只有几个转向 |
| E | Sólo algunas vueltas | CZ | Pouze několik otáček | 한국어 | 두 세번만 |
| PT | Noções básicas | SK | Len niekoľko otáčok | 日本語 | 数回転のみ |
| S | Endast några varv | SLO | Le nekaj obratov | ไทย | หมุนเพียงไม่กี่รอบ |
| FIN | Vain muutama kierros | | | | |

3



x4



x4



x4

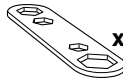

x1

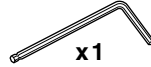

x1

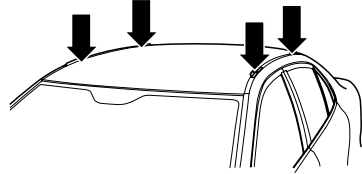
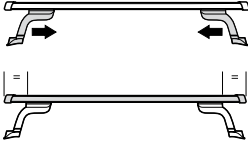

A

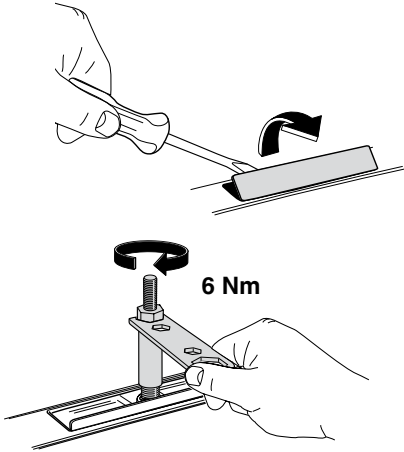

B

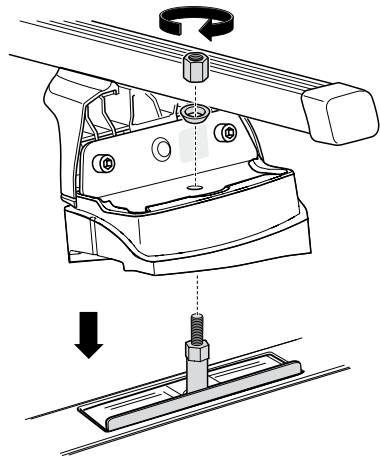

C

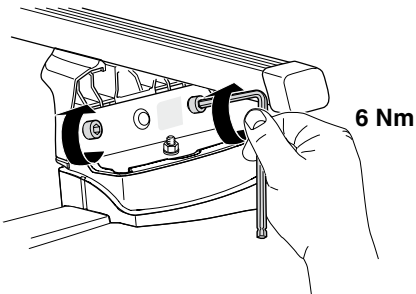

D

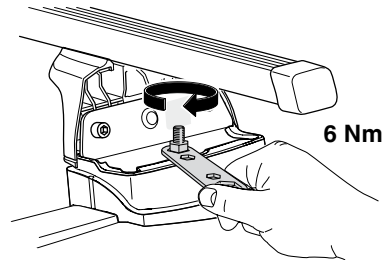

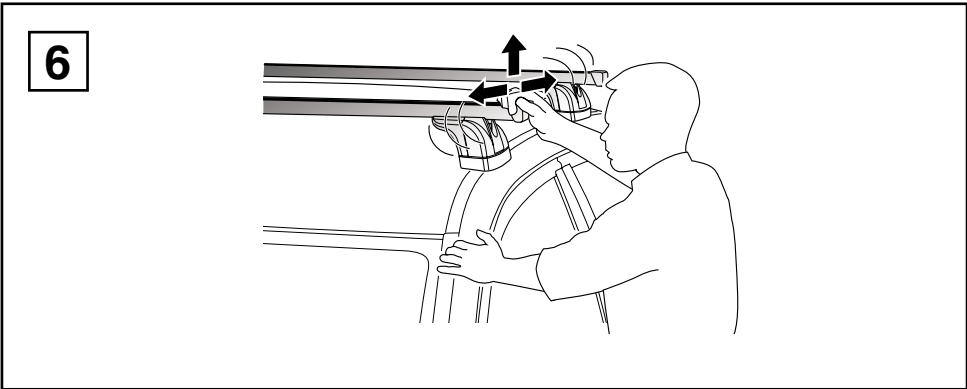
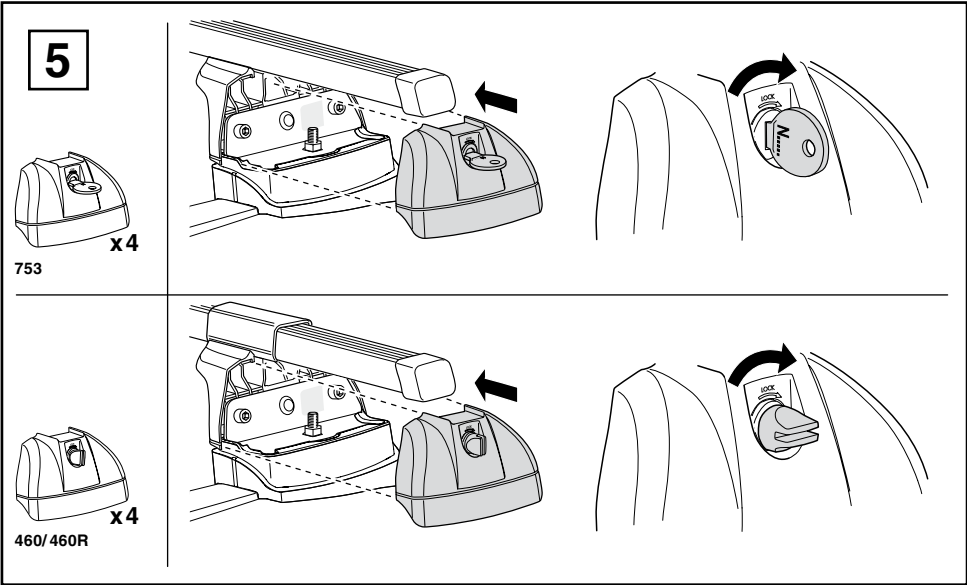
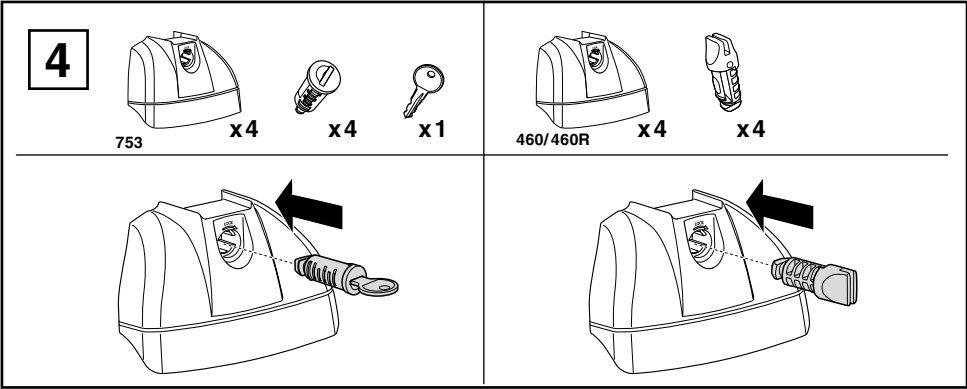

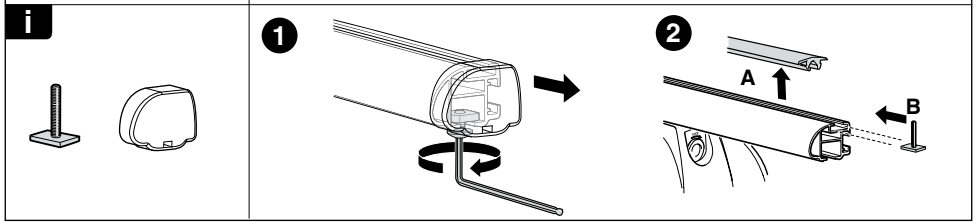
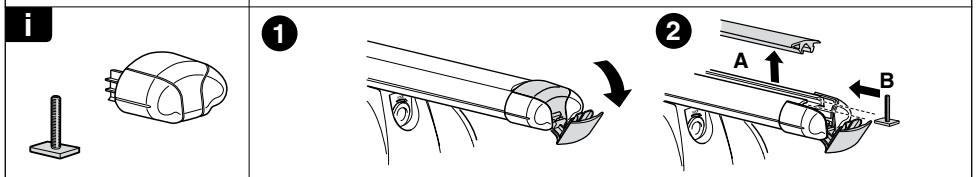
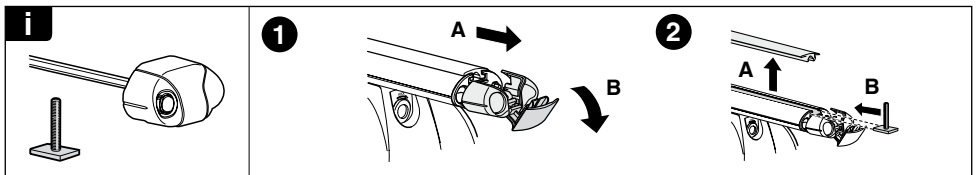
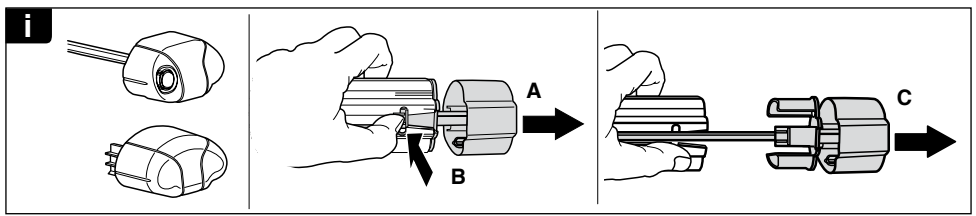
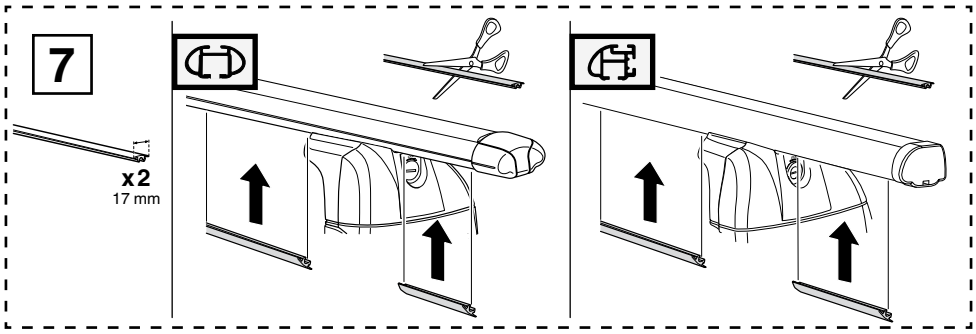

THULE
SWEDEN
**ONE
KEY
SYSTEM**

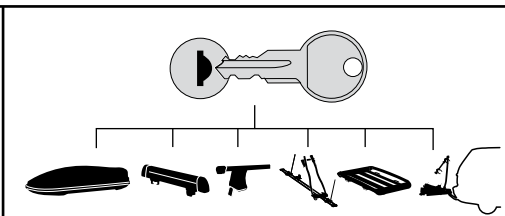

- 544 (x4)
- 596 (x6)
- 588 (x8)
- NA 510 (x10)
- EUR 452 (x12)
- ASIA