

# Kit 3051

**CITROËN Dispatch**, 4/5-dr Van, 07–

**CITROËN Jumpy**, 4/5-dr Van, 07–

**FIAT Scudo**, 4/5-dr Van, 07–

**PEUGEOT Expert**, 4/5-dr Van, 07–

This Kit is only for vehicles with fixpoint mounting.

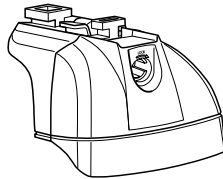

460R  
753

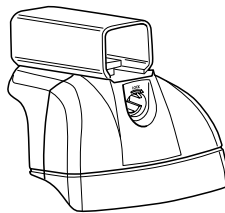
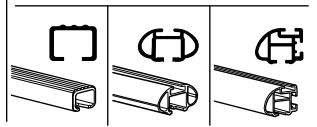

460

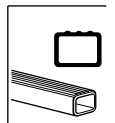

6 kg / 13 lbs + xx kg xx lbs =
 

Max.
100 kg
Max.
220 lbs

9 kg / 20 lbs + xx kg xx lbs =
 

Max.
150 kg
Max.
330 lbs

12 kg / 26 lbs + xx kg xx lbs =
 

Max.
200 kg
Max.
440 lbs

**Kit**



753



x4



x4



x4



x8

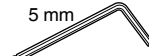

x1



x4



x1

460R



x4



x4



x4



x8

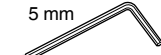

x1



x4

460

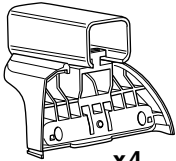

x4



x4



x4



x8

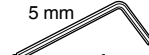

x1



x4



x2



x2

17 mm



x2

23 mm



x2

23 mm



x2



x2

17 mm

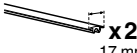

x2

23 mm

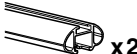

x2



x2



x2



x4

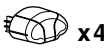

x4



x4

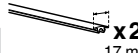

x2

25 mm

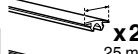

x2



x2

x2



x4

x4



x1

5 mm

1



753/460R



460

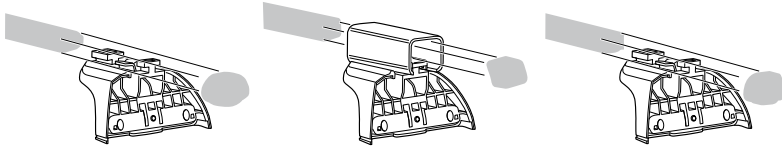

x4

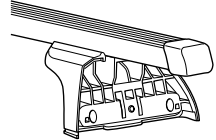
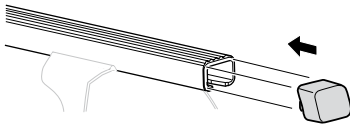

x4

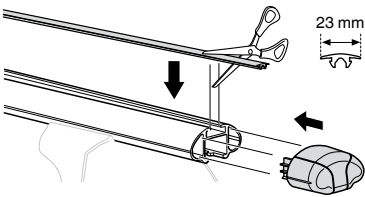

23 mm

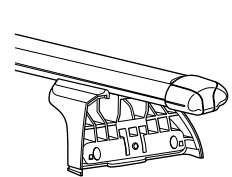
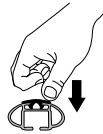

x4

x4

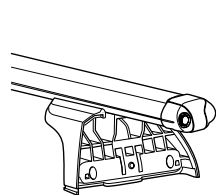
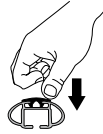
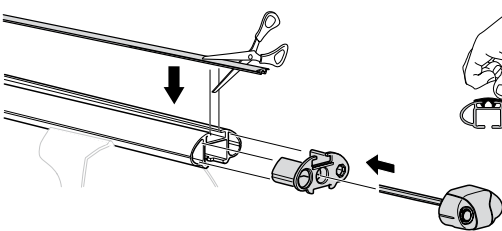

x4

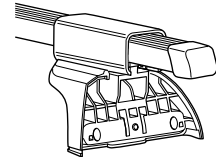
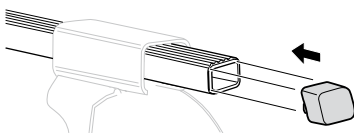

x2

x2

x4

x4

x1

5 mm

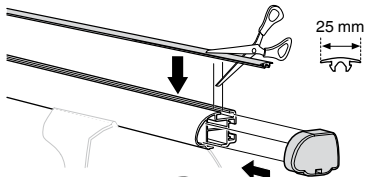

25 mm

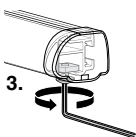
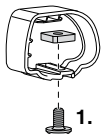
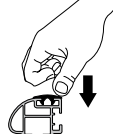

2.

1.

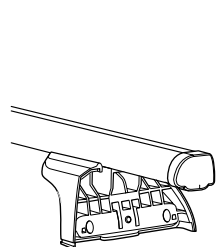

2

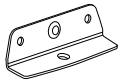

◀ 01 x 4

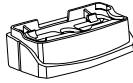

◀ 71 x 4

16 mm  x 8



x 1

01



71

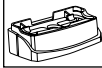

01



71

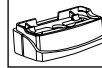

01



71

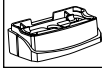

01



71

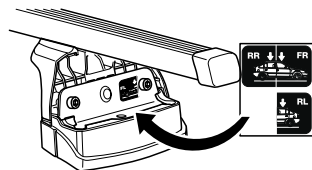
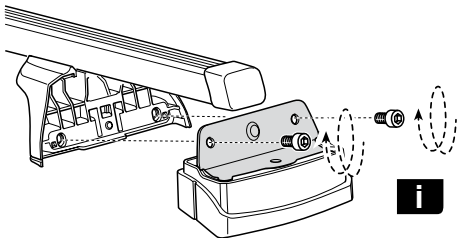
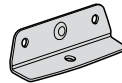
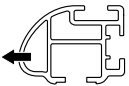
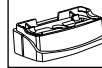

**GB** Only a few turns  
**D** Nur wenige Umdrehungen  
**F** Quelques tours uniquement  
**NL** Slechts enkele slagen  
**I** Solo qualche giro  
**E** Sólo algunas vueltas  
**PT** Noções básicas  
**S** Endast några varv  
**FIN** Vain muutama kierros

**EST** Ainult mõni pööre  
**LAT** Tikai dažī apgriezieni  
**LIT** Tik keli pasukimai  
**PL** Wystarczy kilka obrotów  
**RU** Достаточно нескольких оборотов  
**CZ** Pouze několik otáčecí  
**SK** Len niekoľko otáčok  
**SLO** Le nekaj obratov

**HR** Samo nekoliko okreta  
**HU** Csak néhány fordítás  
**GR** Μόνο μερικές στροφές  
**TR** Yalnız birkaç kez çevirm  
**中文** 只有几个转向  
**한국어** 두 세번만  
**日本語** 数回転のみ  
**ไทย** หมุนเพียงไม่กี่รอบ

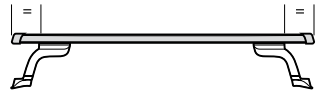
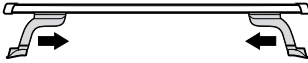
**3****x 4****x 4****x 4****x 4**

15 mm

**x 4**

10 mm

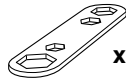
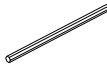
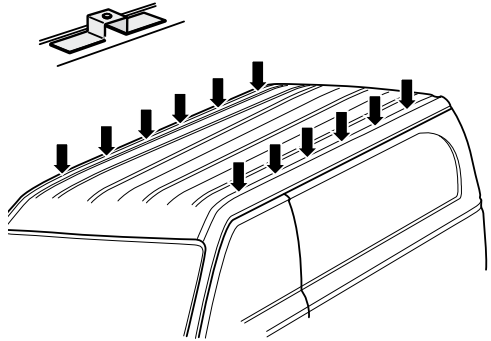
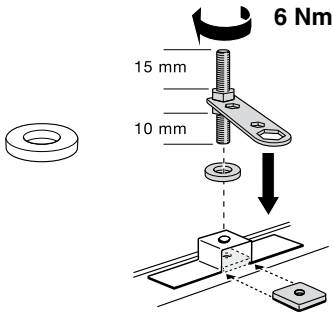
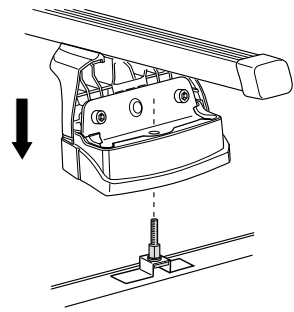
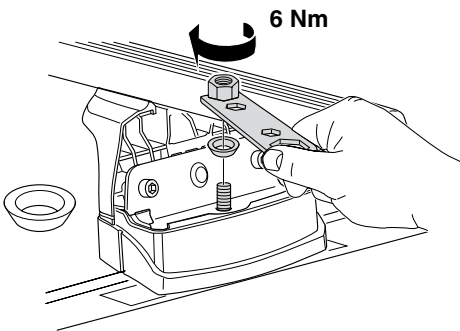
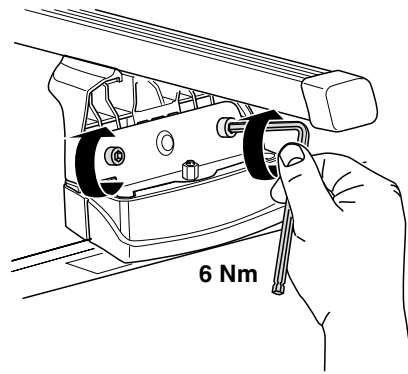
**x 1****x 1****A****B****C****D**

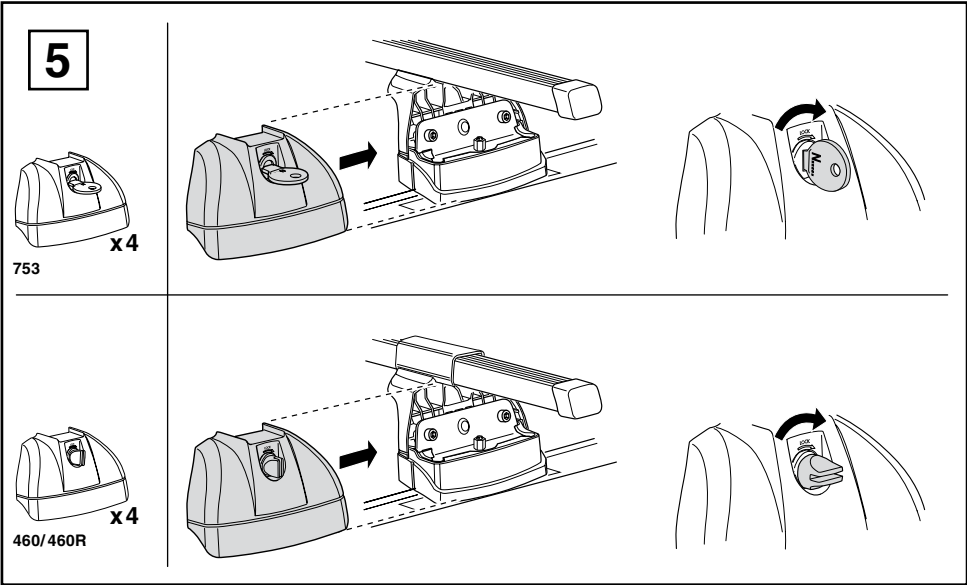
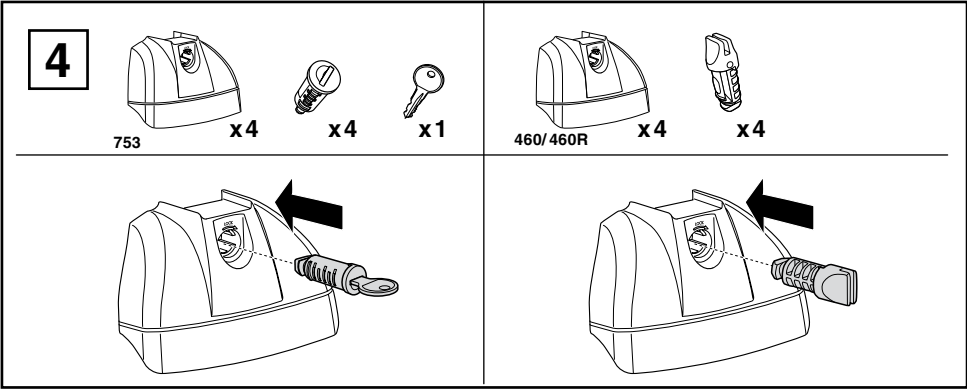

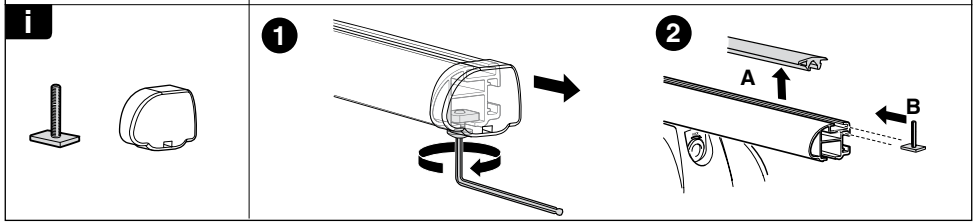
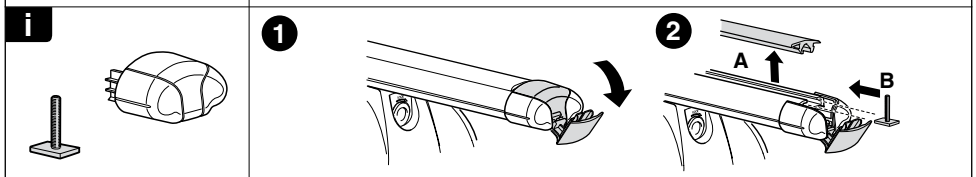
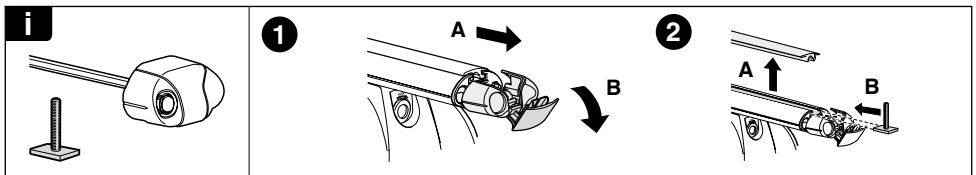
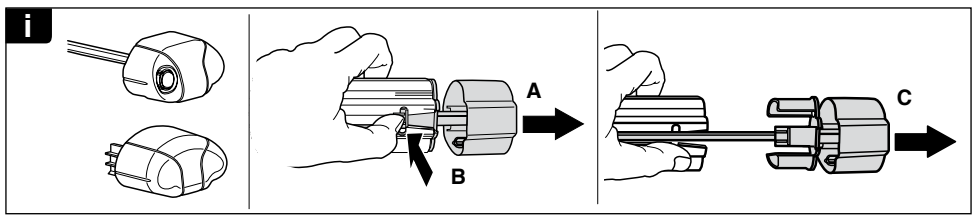
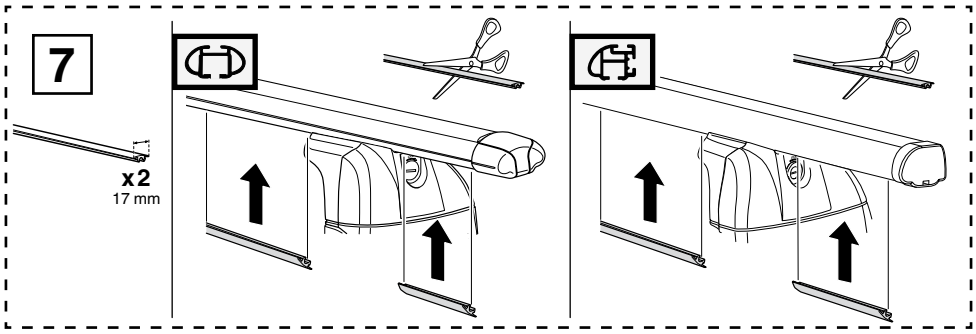

**THULE**  
SWEDEN  
**ONE  
KEY  
SYSTEM**

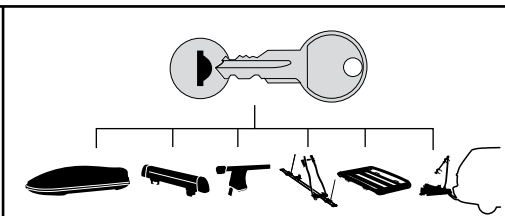

- 544 (x4)
- 596 (x6)
- 588 (x8)
- 510 (x10)
- NA EUR ASIA 452 (x12)