

Kit 3062

CHEVROLET Trailblazer, 5-dr SUV, 02–
MERCEDES Sprinter, 4-dr Van, 06–
RENAULT Espace, 5-dr MPV, 03–
VOLKSWAGEN Crafter, 4-dr Van, 06–

This kit is only for vehicles with T-profile

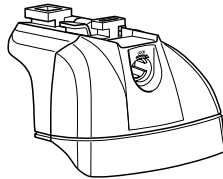

460R
753

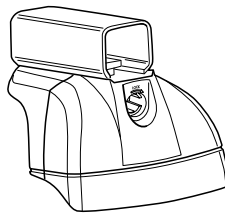
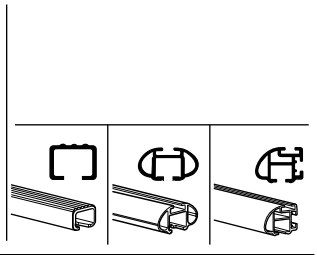

460

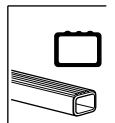

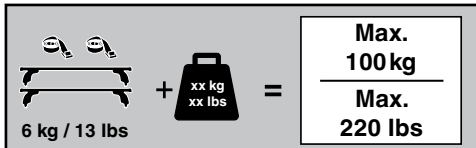

6 kg / 13 lbs + xx kg xx lbs = **Max. 100 kg**
Max. 220 lbs

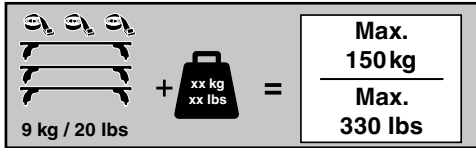

9 kg / 20 lbs + xx kg xx lbs = **Max. 150 kg**
Max. 330 lbs

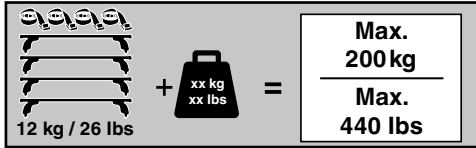

12 kg / 26 lbs + xx kg xx lbs = **Max. 200 kg**
Max. 440 lbs

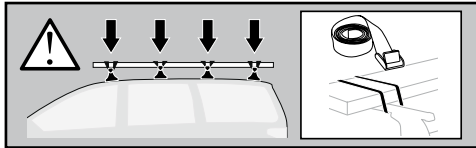
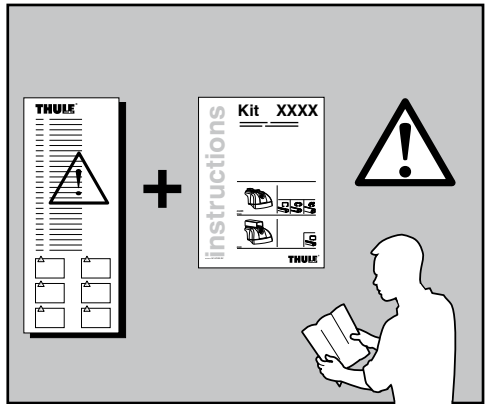
THULE Kit XXXX

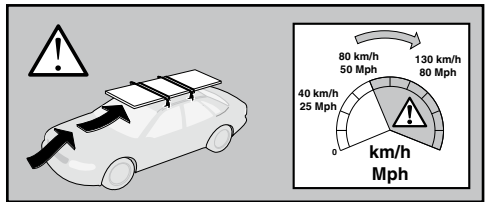

80 km/h 50 Mph 130 km/h 80 Mph
40 km/h 25 Mph 0 km/h 0 Mph
km/h Mph

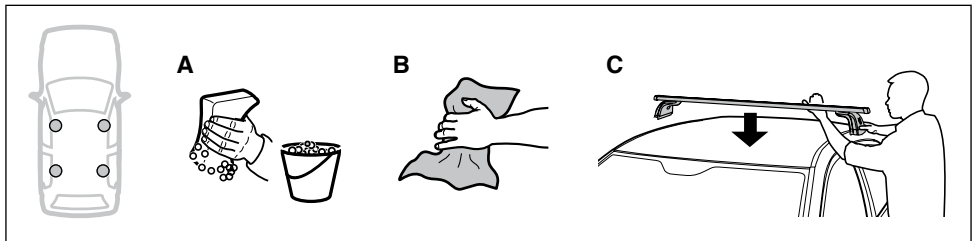

A B C

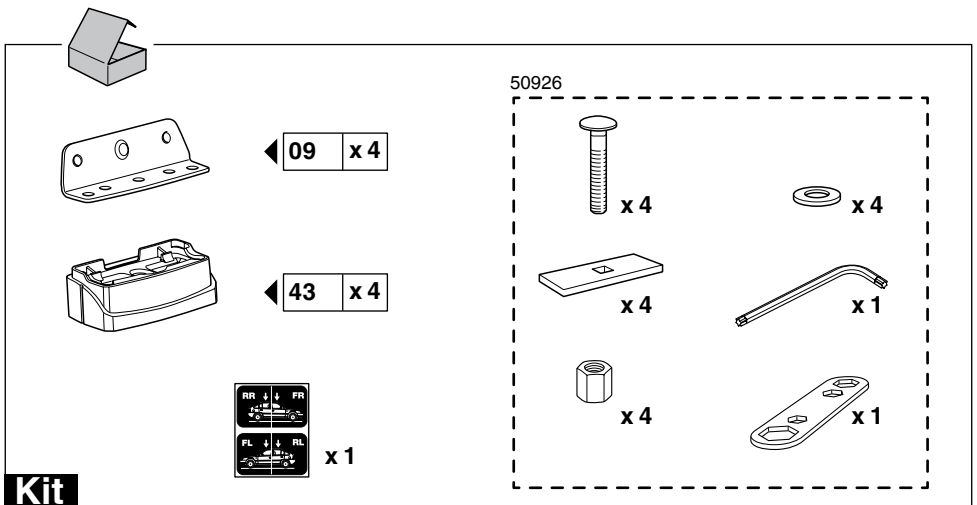

50926

09 x 4

43 x 4

x 1

x 4 x 4 x 4 x 1 x 4 x 1

Kit

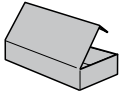

753

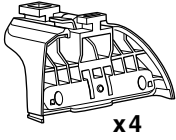

x4



x4



x4



x8

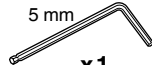

x1



x4



x1

460R

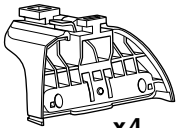

x4



x4



x4



x8

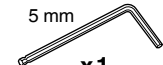

x1



x4

460

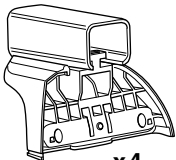

x4



x4



x4



x8

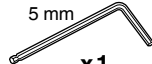

x1



x4

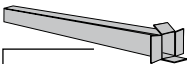

x2



x2



x2



x2



x2



x2

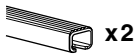

x2

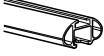

x2

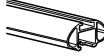

x2

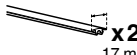

x2

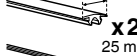

x2



x2

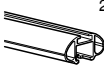

x2



x4

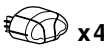

x4



x4

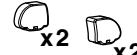

x2

x2

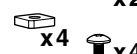

x4

x4



x1

1

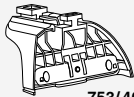

753/460R

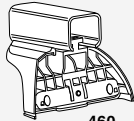

460

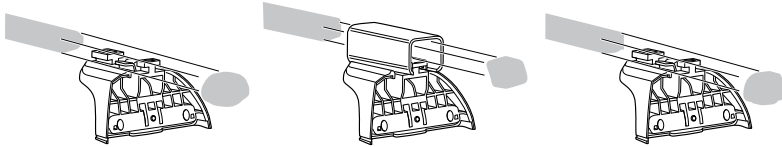

x4

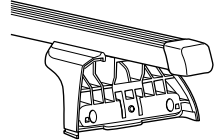
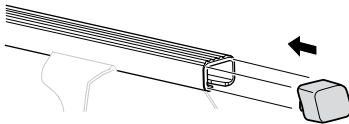

x4

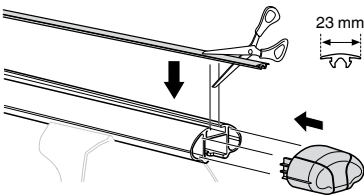

23 mm

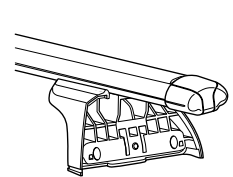
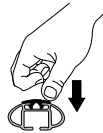

x4

x4

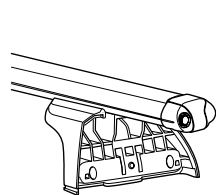
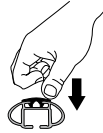
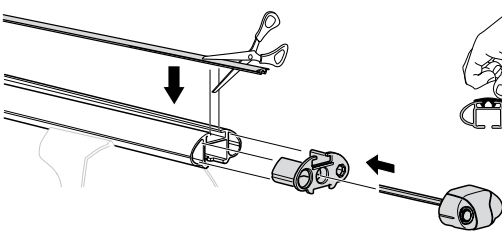

x4

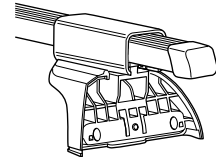
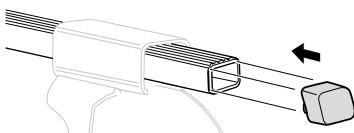

x2

x2

x4

x4

x1
5 mm

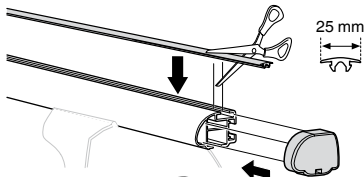

25 mm

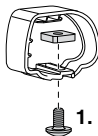
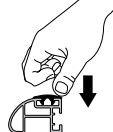

1.

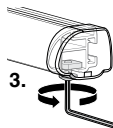

3.

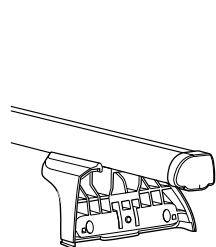

2

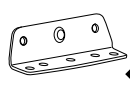

09 x 4



43 x 4

16 mm x 8

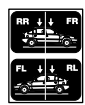

x 1

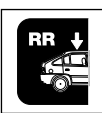
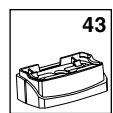
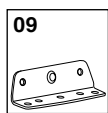
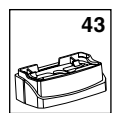
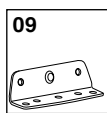
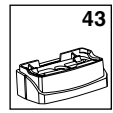
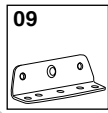
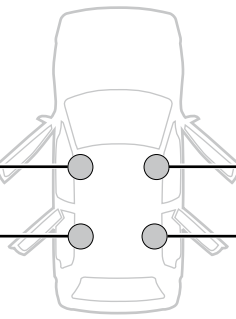
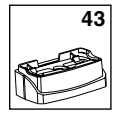
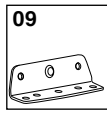

GB If the original-fit roof rack is used, remove these.
D Wenn Original-Lastenträger angebaut sind, müssen diese entfernt werden.
F Si la voiture est munie d'une galerie d'origine, il convient de la retirer.
NL Als er een originele allesdrager is, moet deze worden verwijderd.
I Se si utilizza il portapacchi originale, rimuoverli.
E Quitar el porta-equipajes original, si lo hubiera.
PT Se o bagageiro de teto original estiver sendo usado, remova-os.
S Om originaltäckräcken finns, ta bort dessa.
FIN Jos autossa on alkuperäinen kattoteline, poista se.
EST Kui tehasepoole pakiraam on kasutusel, eemaldage see.
LAT Ja tiek izmantots oriģinālais rūpnīcā uzstādītais jumta bagāžnieks, noņemiet tos.
LIT Jei naudojami originalūs stogo laikikliai, tai nuimkite.
PL Jeżeli na dachu jest fabrycznie zamontowany bagażnik, zdemontuj go.
RU При использовании оригинального багажника для крыши снимите его.
CZ Jestliže jsou vestaveny originální nosiče, musí být tyto odstraněny.
SK Ak je použitá originálna strešná konštrukcia, tieto odložte.
SLO Odstranite originalne nosilce.
HR Ako koristite originalni krovni nosač, skinite ga.
HU Ha az eredeti csomagtartót használja, vegye azt le.
GR Αν χρησιμοποιείται η πρωτότυπη σχάρα οροφής, αυτή πρέπει να αφαιρεθούν.
TR Aracın orijinalinden monteli bir portbagaj bulunuyorsa, bunu sökün.
中文 如果使用原装车顶行李架，则拆除这些装置
한국어 차량 출고 시 장착된 짐반이 있는 경우, 이를 분리하십시오.
日本語 屋根ラックがもともと取り付けられている場合はそれを取り外してください。
ไทย หากใช้ราชมบนหลังคาที่ติดตั้งไว้ดั้งเดิม ให้ถอดออก

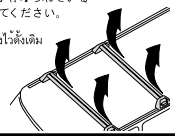

i

GB Only a few turns
D Nur wenige Umdrehungen
F Quelques tours uniquement
NL Slechts enkele slagen
I Solo qualche giro
E Sólo algunas vueltas
PT Noções básicas
S Endast några varv
FIN Vain muutama kierros
EST Ainult mõni pööre
LAT Tikai dažī apgriezieni
LIT Tik keli pasukimai

PL Wystarczy kilka obrotów
RU Достаточно нескольких оборотов
CZ Pouze několik otáček
SK Len niekoľko otáčok
SLO Le nekaj obratov
HR Samo nekoliko okreta
HU Csak néhány fordítás
GR Μόνο μερικές στροφές
TR Yalnız birkaç kez çevirm
中文 只有几个转向
한국어 두 세번만
日本語 数回転のみ
ไทย หมุนเพียงไม่กี่รอบ

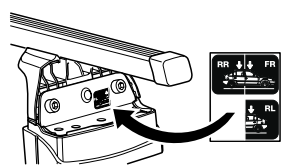
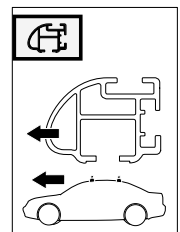
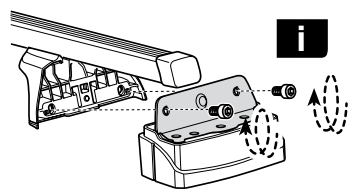
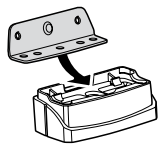

3

x 4



x 1

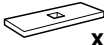

x 4



x 4



x 1



x 4

CHEVROLET Trailblazer, 5-dr SUV, 02-

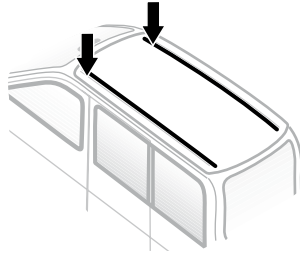

A

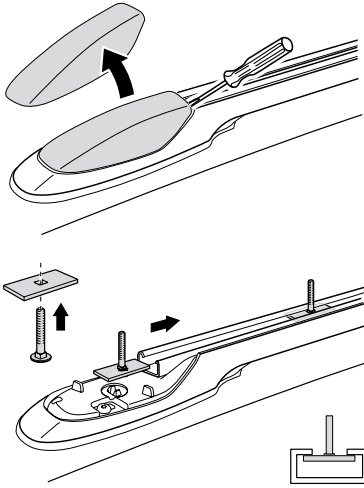

B

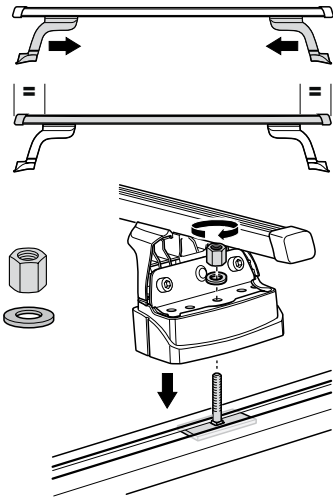

C

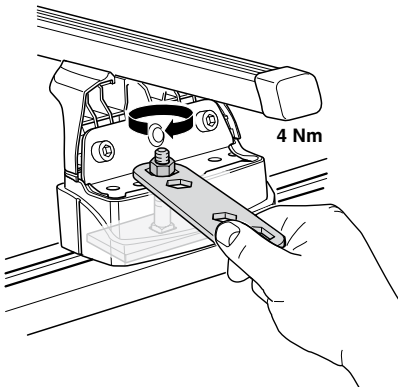

D

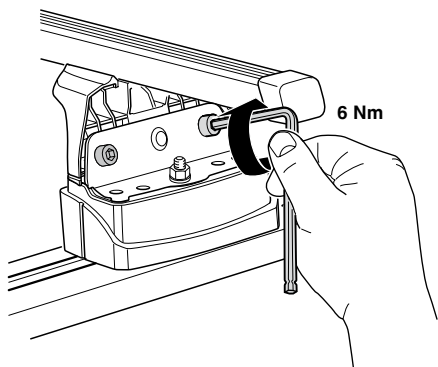

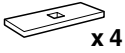
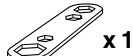
3

MERCEDES Sprinter, 4-dr Van, 06–
RENAULT Espace, 5-dr MPV, 03–
VOLKSWAGEN Crafter, 4-dr Van, 06–

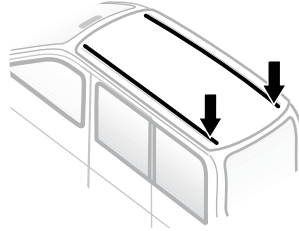
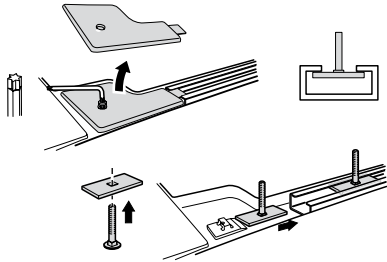
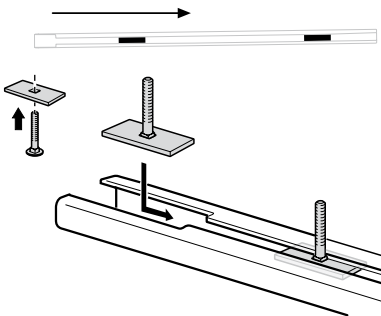
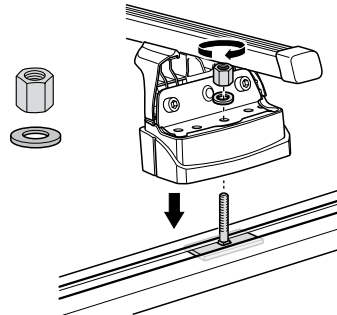
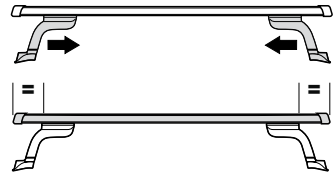
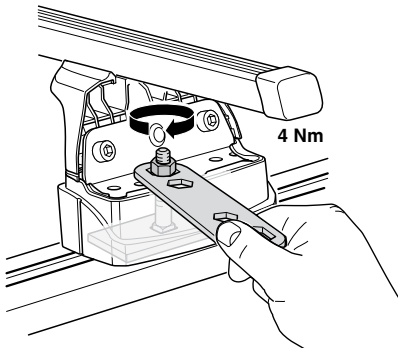
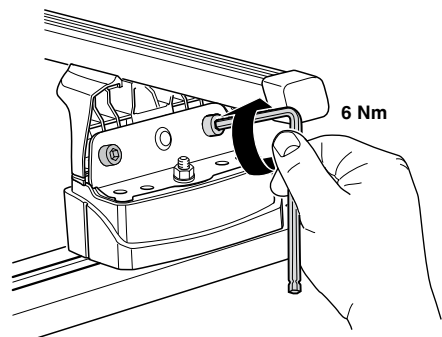
**A** **RENAULT****MERCEDES
VOLKSWAGEN****B****C****D**

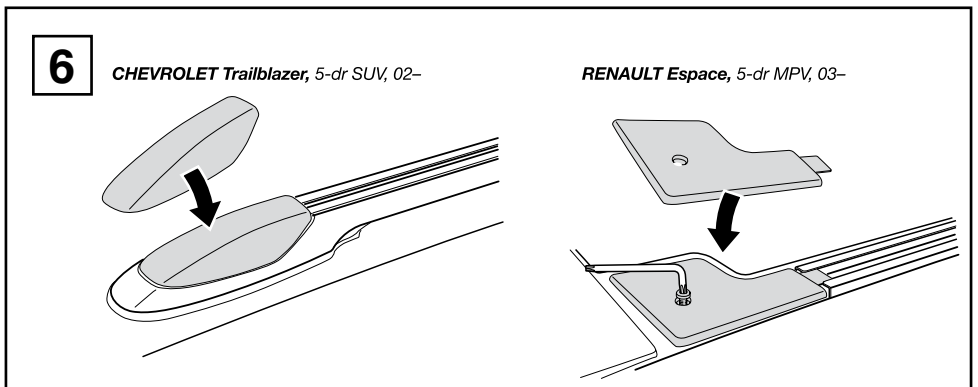
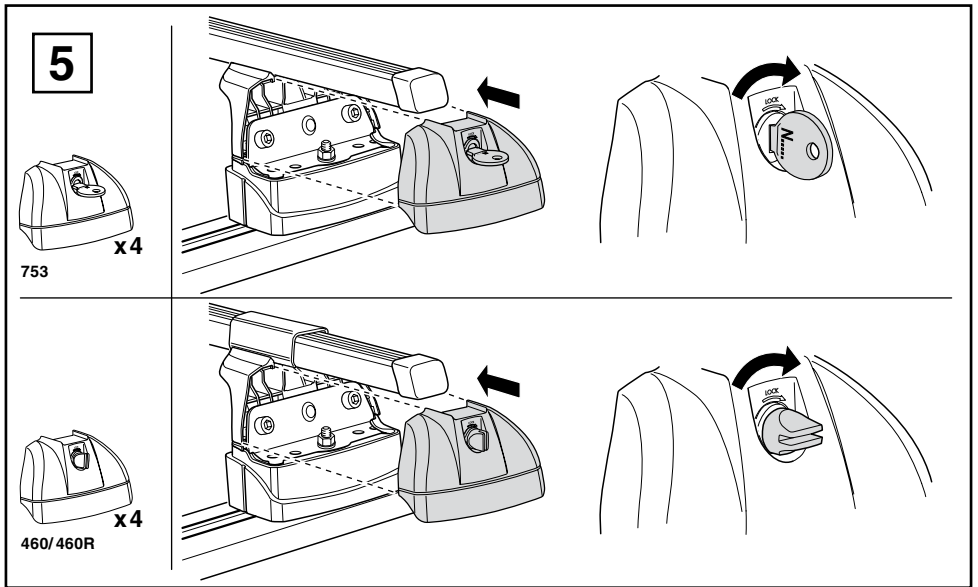
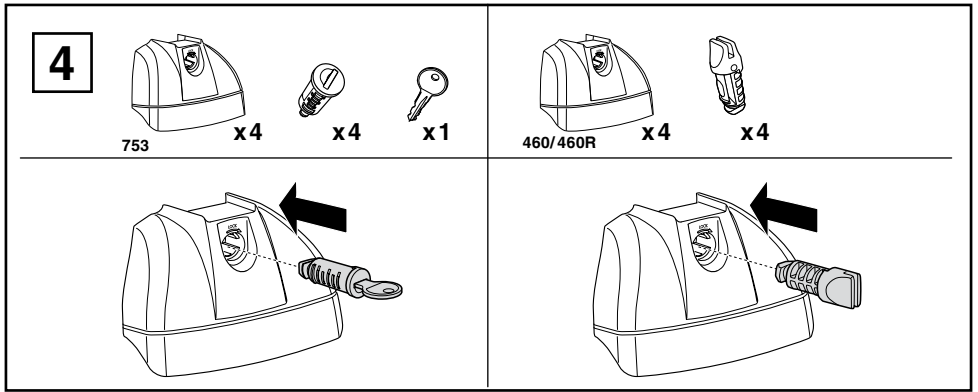

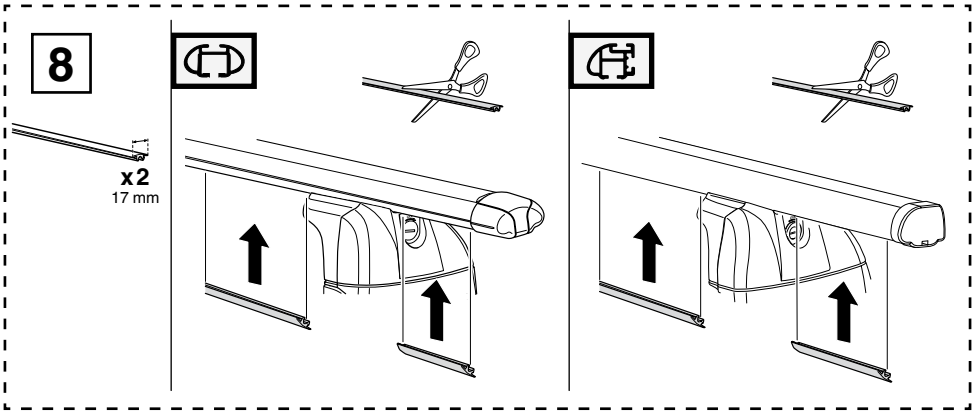
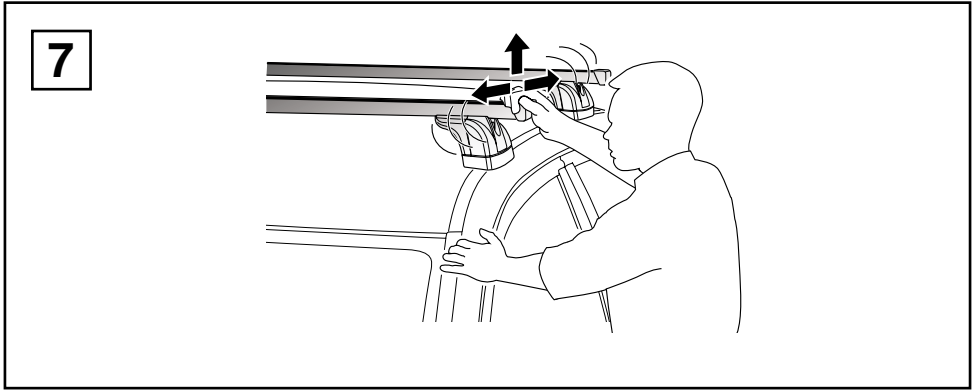

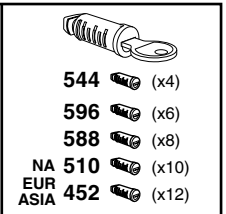
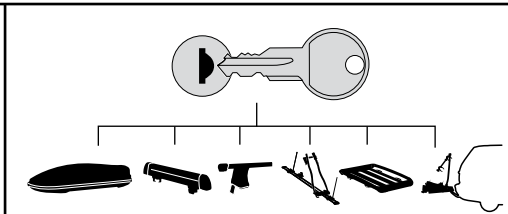
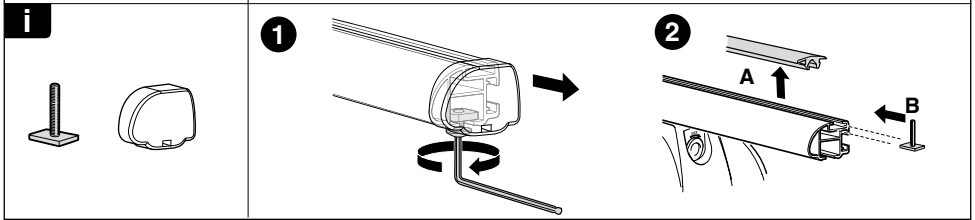
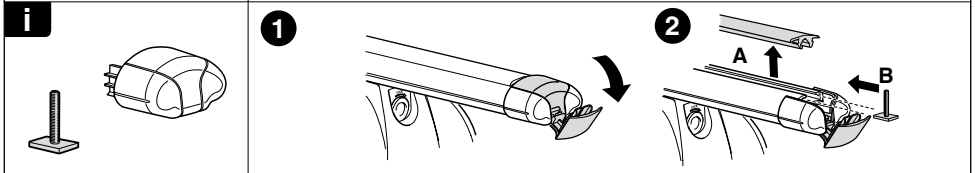
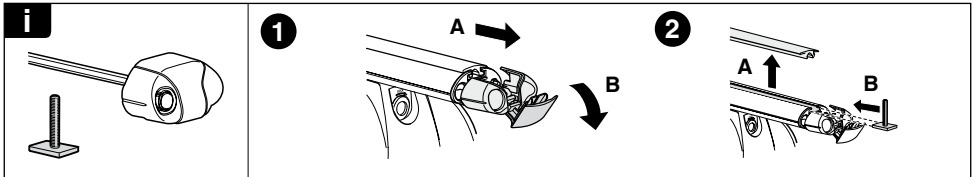
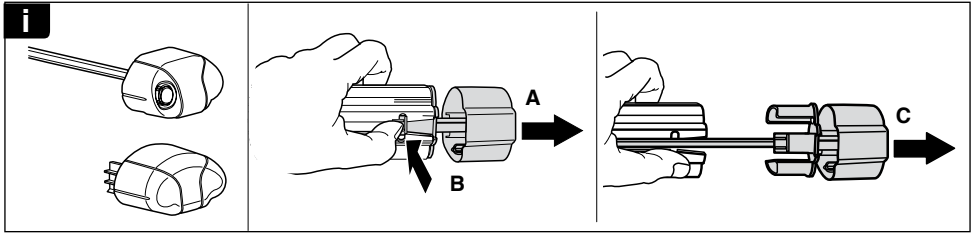

ww ▶ Thule Sweden AB, Box 69, 330 33 Hillerstorp, SWEDEN
 NA ▶ Thule Inc., 42 Silvermine Road, Seymour, Connecticut 06483, USA

info@thule.com
 customer.service@thule.com

www.thule.com