

Kit 3085

NISSAN NV200, 5-dr MPV, 10-

NISSAN NV200, 5-dr Van, 10-

This Kit is only for vehicles with fixpoint mounting.

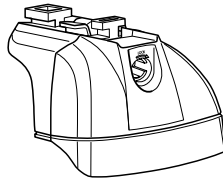

460R
753

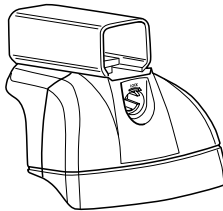
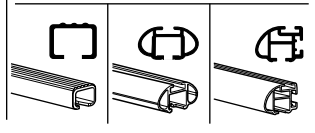

460

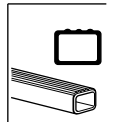

6 kg / 13 lbs + xx kg / xx lbs = **Max. 65kg**
Max. 143 lbs

9 kg / 20 lbs + xx kg / xx lbs = **Max. 100kg**
Max. 220 lbs

Warning: Do not exceed weight limits. Do not use on car seats.

THULE + Kit XXXX instructions

Warning: Do not exceed speed limits.

A B C

50961

- 22 x 4
- 104 x 2
- 105 x 2
- 22 x 22 x 22 x 1
- 30 mm x 2
- 45 mm x 2
- 6 mm x 1

Kit

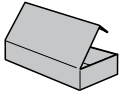

753



x4



x4



x4



x8



x1



x4



x1

460R

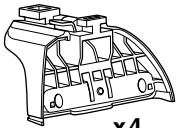

x4



x4



x4



x8



x1



x4

460

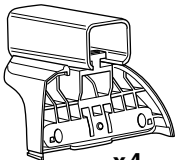

x4



x4



x4



x8



x1



x4



x2



x2

17 mm



x2

23 mm



x2

23 mm



x2



x2

17 mm

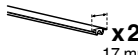
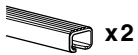

x2

23 mm

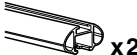

x2

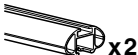

x2

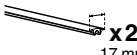

x2

25 mm

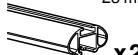

x2



x4

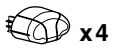

x4



x4

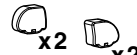

x2

x2

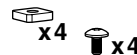

x4

x4



x1

5 mm

1

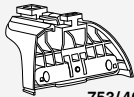

753/460R

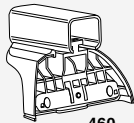

460

+

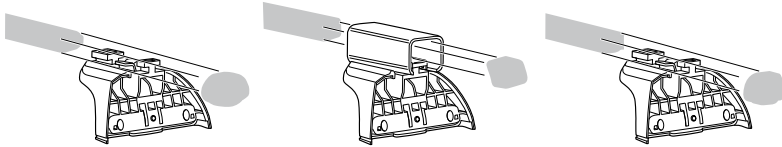

x4

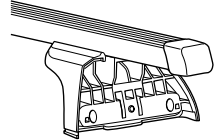
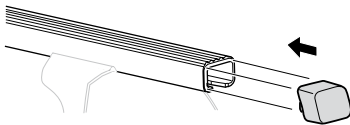

x4

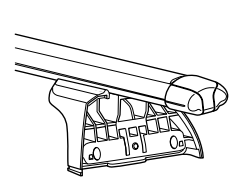
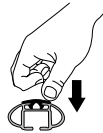
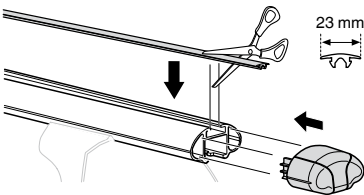

x4

x4

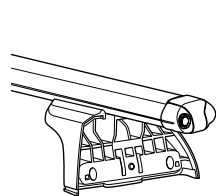
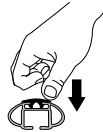
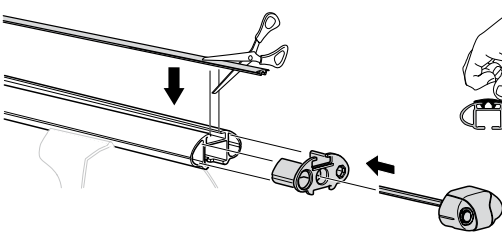

x4

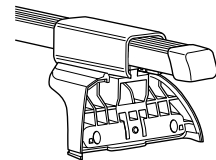
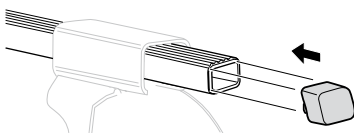

x2

x2

x4

x4

x1
5 mm

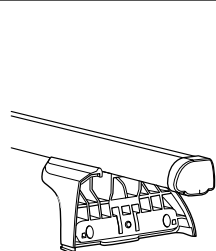
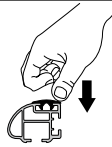
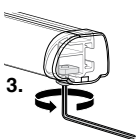
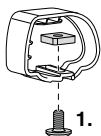
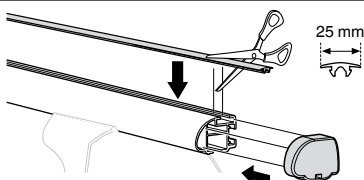

2

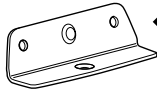

22 x 4

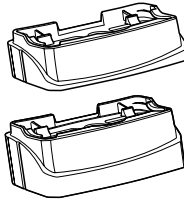

104 x 2

105 x 2



x 8



x 1

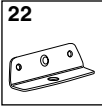

105

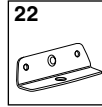

105

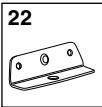

104

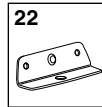

104



Kit 3085

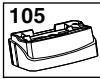
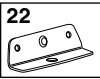

Kit 3085

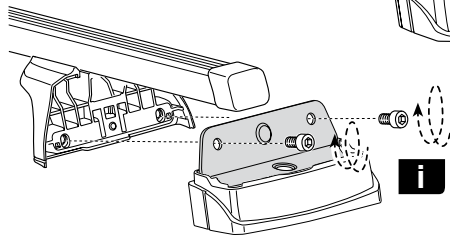
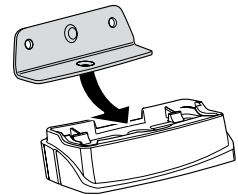
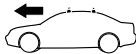
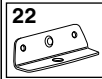

i

i

- GB** Only a few turns
- D** Nur wenige Umdrehungen
- F** Quelques tours uniquement
- NL** Slechts enkele slagen
- I** Solo qualche giro
- E** Sólo algunas vueltas
- PT** Noções básicas
- S** Endast några varv
- FIN** Vain muutama kierros
- EST** Ainult mõni pööre
- LAT** Tikai dažī apgriezieni
- LIT** Tik keli pasukimai
- PL** Wystarczy kilka obrotów
- RU** Достаточно нескольких оборотов
- CZ** Pouze několik otáček
- SK** Len niekoľko otáčok
- SLO** Le nekaj obratov

- HR** Samo nekoliko okreta
- HU** Csak néhány fordítás
- GR** Μόνο μερικές στροφές
- TR** Yalnız birkaç kez çevirm
- 中文** 只有几个转向
- 한국어** 두 세번만
- 日本語** 数回転のみ
- ไทย** หมุนเพียงไม่กี่รอบ

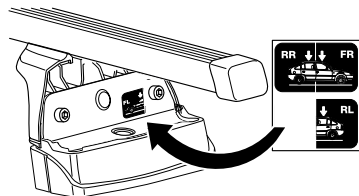

3

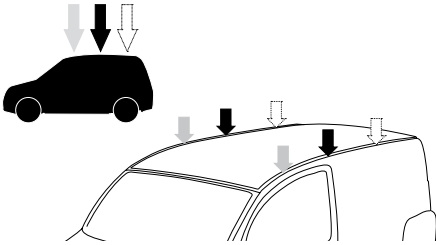
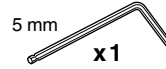
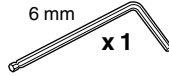
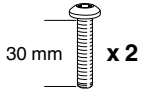

A

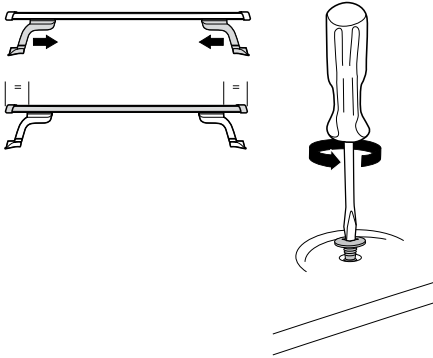

B

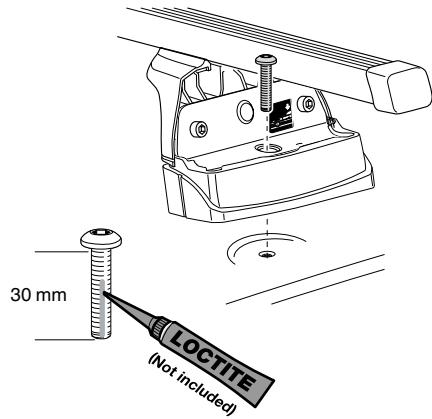

C

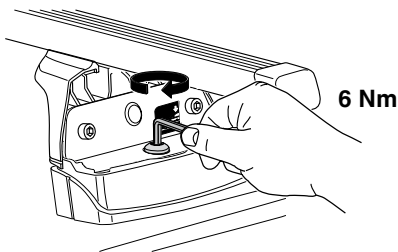

D

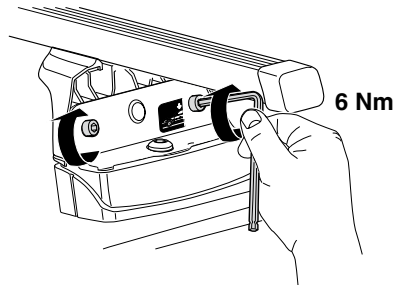

3

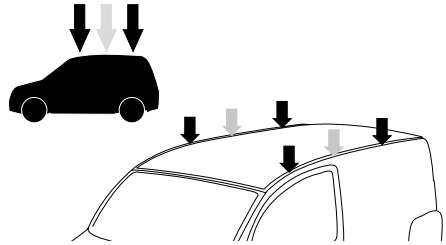
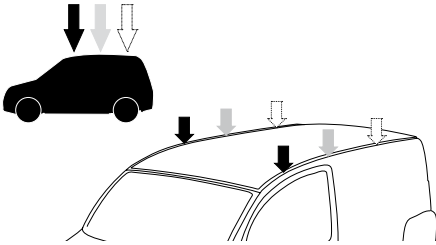
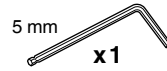
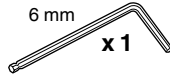
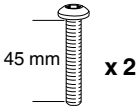

A

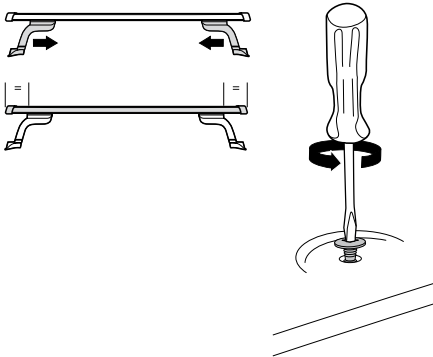

B

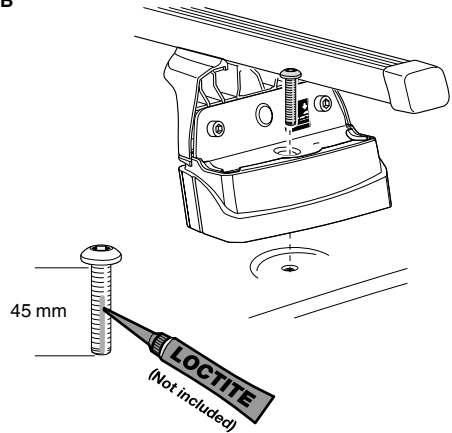

C

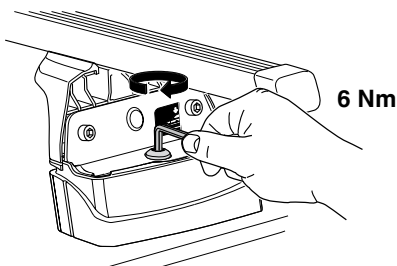

D

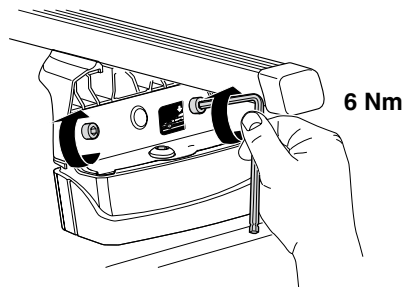

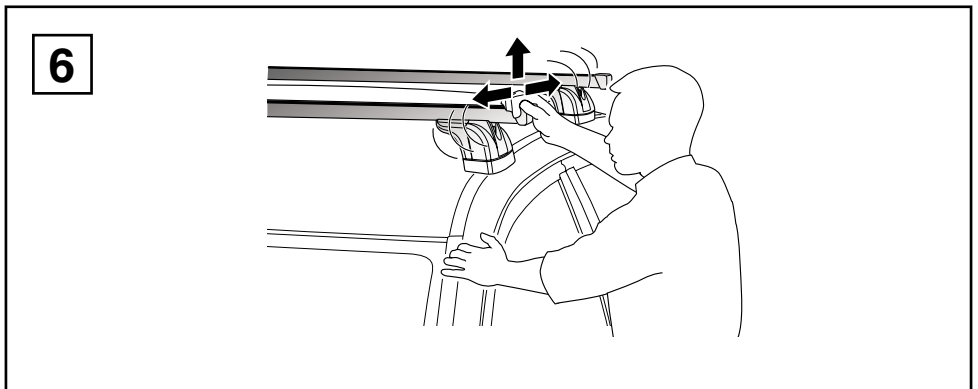
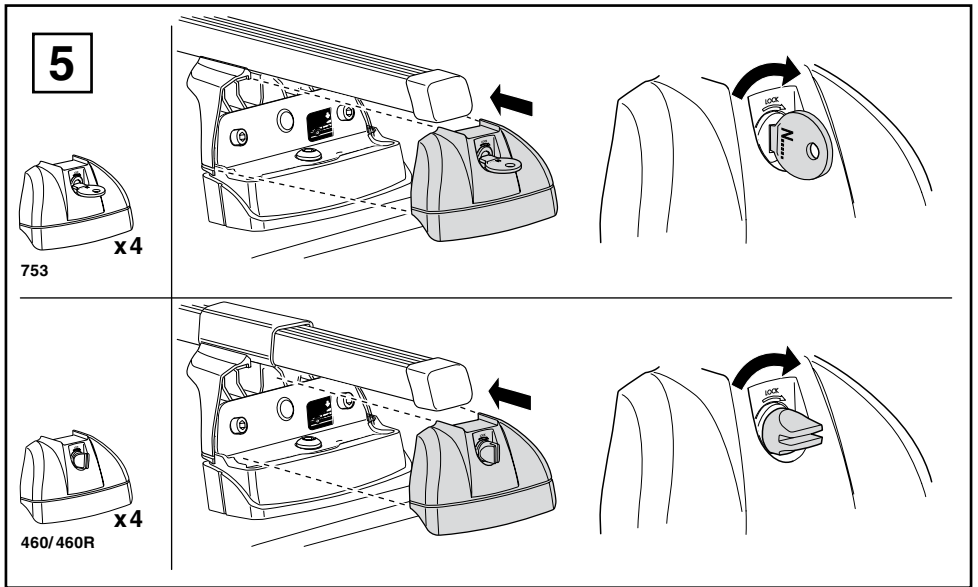
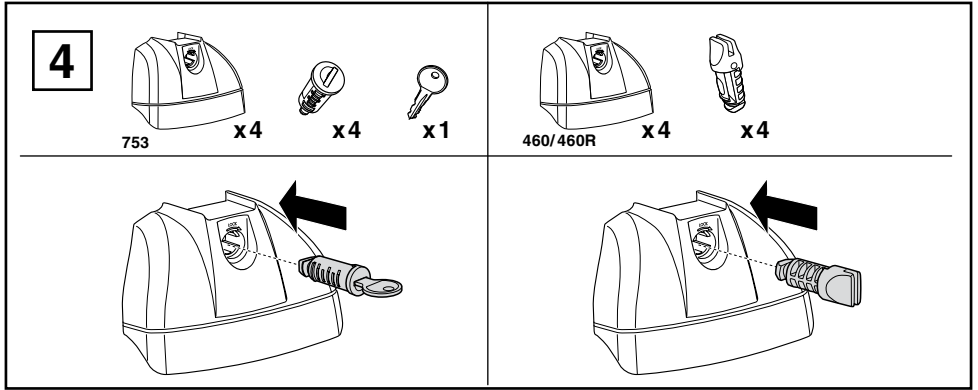

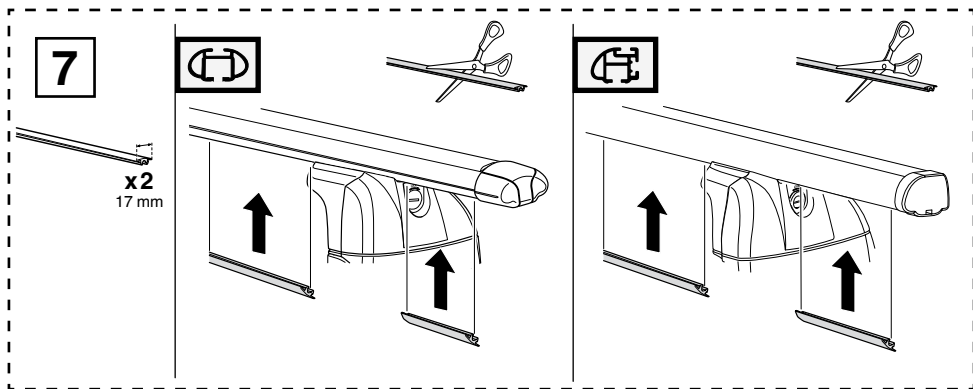

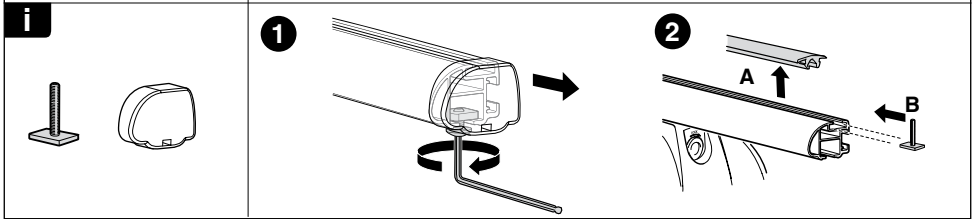
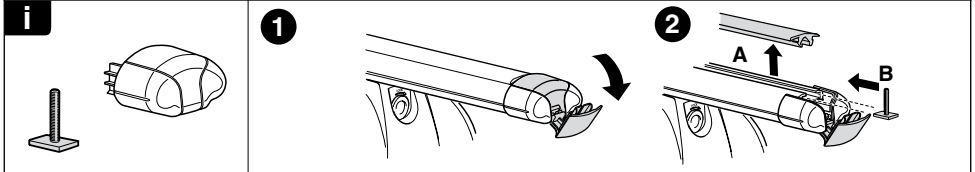
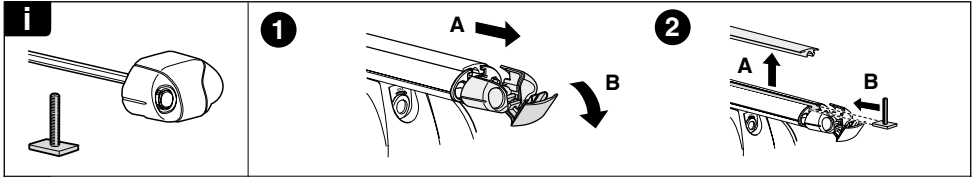
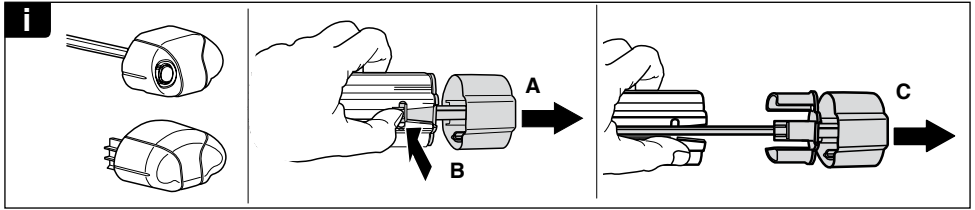



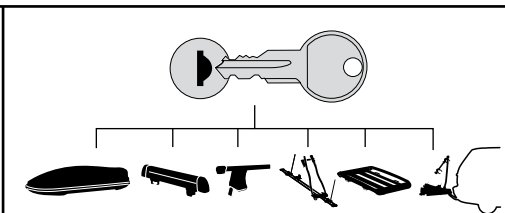



THULE
SWEDEN
**ONE
KEY
SYSTEM**



-  **544** (x4)
 -  **596** (x6)
 -  **588** (x8)
 -  **510** (x10)
 -  **452** (x12)
- NA
EUR
ASIA