

# Kit 3096

**NISSAN Interstar**, 4-dr Van, 10-  
**NISSAN NV400**, 4-dr Van, 10-  
**OPEL Movano**, 4-dr Van, 10-  
**RENAULT Master**, 4-dr Van, 10-  
**VAUXHALL Movano**, 4-dr Van, 10-

This Kit is only for vehicles with fixpoint mounting.

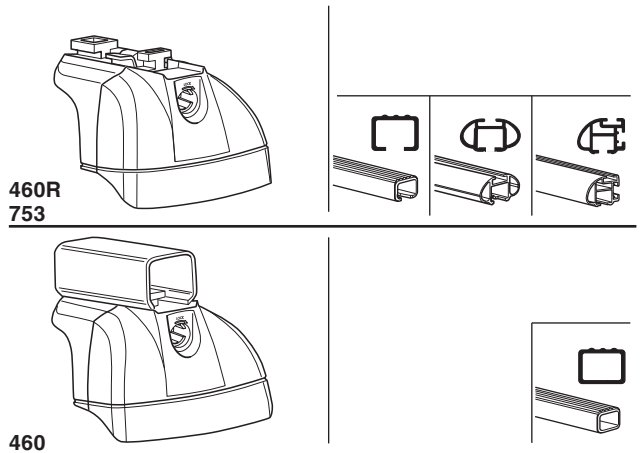

6 kg / 13 lbs + xx kg xx lbs =

**Max. 100 kg**  
**Max. 220 lbs**

9 kg / 20 lbs + xx kg xx lbs =

**Max. 150 kg**  
**Max. 330 lbs**

12 kg / 26 lbs + xx kg xx lbs =

**Max. 200 kg**  
**Max. 440 lbs**

THULE Kit XXXX

instructions

THULE

80 km/h 130 km/h  
50 Mph 80 Mph

40 km/h 25 Mph

km/h  
Mph

A B C

50575 x 8

51293 x 1

51325 x 8

30146 x 8

Kit

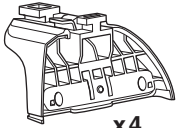
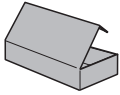

753

x4



x4



x4



16 mm  
x8



5 mm  
x1



x4



x1

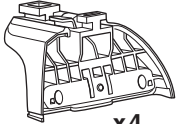

460R

x4



x4



x4



16 mm  
x8



5 mm  
x1



x4

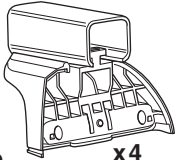

460

x4

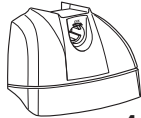

x4



x4



16 mm  
x8

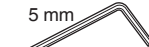

5 mm  
x1



x4

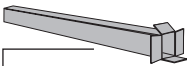

x2



x1

17 mm



x2

23 mm



x2

23 mm



x2



x2

17 mm

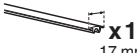

x2

23 mm

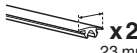

x2

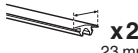

x2

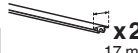

x2

25 mm

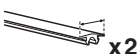

x2



x2



x4



x4



x4

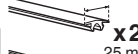

x2



x2

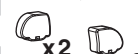

x2



x4



x4



x1

5 mm

1

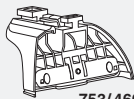

753/460R

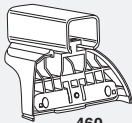

460

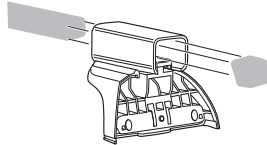
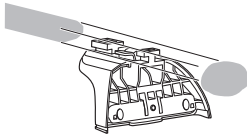

x4

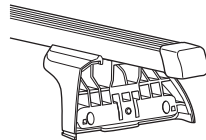
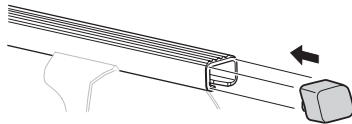

x4

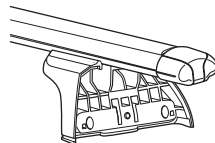
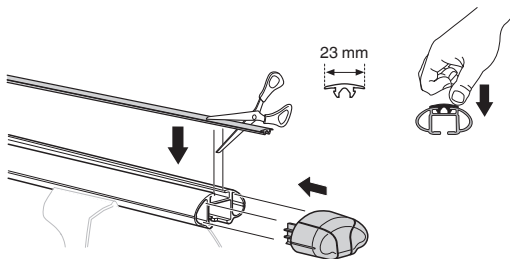



x4

x4

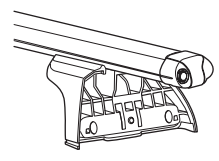
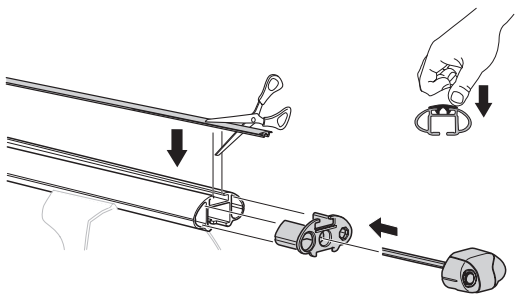

x4

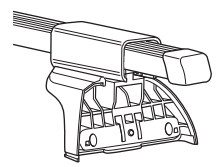
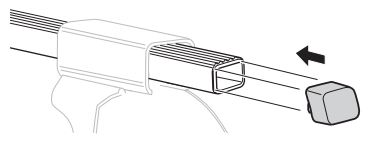

x2

x2

x4

x4

x1  
5 mm

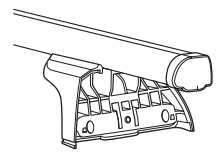
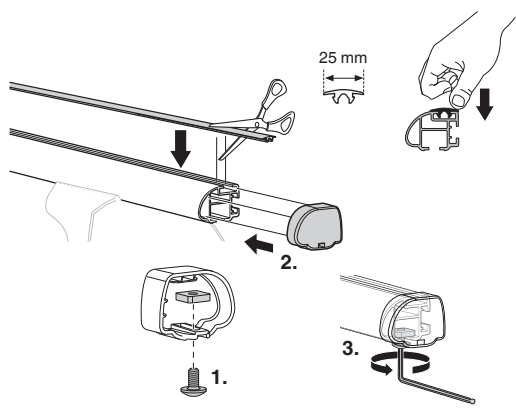

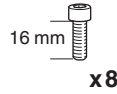
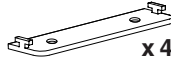
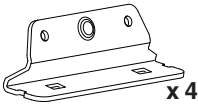
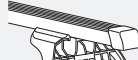
**2****x 1**

753/460R

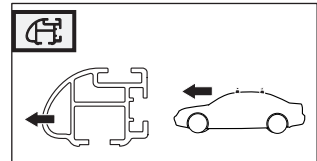
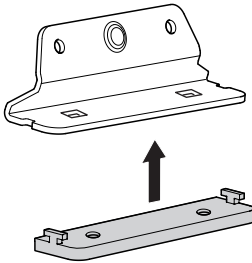

460

**i**

- GB** Only a few turns  
**D** Nur wenige Umdrehungen  
**F** Quelques tours uniquement  
**NL** Slechts enkele slagen  
**I** Solo qualche giro  
**E** Sólo algunas vueltas  
**PT** Noções básicas  
**S** Endast några varv  
**FIN** Vain muutama kierros  
**EST** Ainult mõni pööre  
**LAT** Tikai dažī apgriezieni  
**LIT** Tik keli pasukimai  
**PL** Wystarczy kilka obrotów  
**RU** Достаточно нескольких оборотов  
**CZ** Pouze několik otáček  
**SK** Len niekoľko otáčok  
**SLO** Le nekaj obratov  
**HR** Samo nekoliko okreta  
**HU** Csak néhány fordítás  
**GR** Μόνο μερικές στροφές  
**TR** Yalnız birkaç kez çevirm  
**中文** 只有几个转向  
**한국어** 두 세번만  
**日本語** 数回転のみ  
**ไทย** หมุนเพียงไม่กี่รอบ

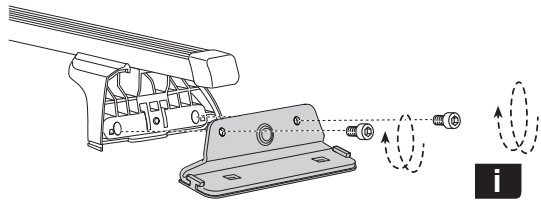
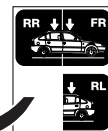
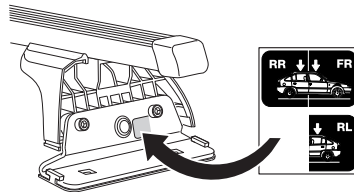
**i**

**3**

x8



x8



x8

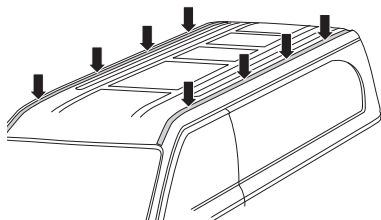
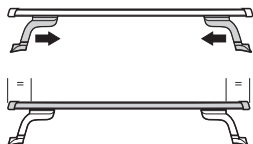

**GB** If there is an interior roof lining, remove it before starting the installation procedure.

**D** Vor Montagebeginn muß ggf. das Innendach gelöst werden.

**F** Si l'habitacle comporte un pavillon séparé, le déposer avant de commencer le montage.

**NL** Als er een binnendak aanwezig is, maak dit dan los voordat u met de montage begint.

**I** Rimuovere l'eventuale modanatura interna del tetto prima di iniziare la procedura di installazione.

**E** Si hay un techo interior, soltarlo antes de empezar el montaje.

**S** Om det finns ett inmertak, lossa detta innan monteringen påbörjas.

**FIN** Jos autossa on sisäkatto, irrota se ennen asennuksen aloittamista.

**EST** Kui eksisteerib sisemine katusevooderdis, eemaldage see enne paigaldamisega alustamist.

**PL** Przed rozpoczęciem montażu usuń ewentualną spodnią część dachu samochodu.

**RU** В случае наличия на крыше декоративных накладок, перед началом установки их необходимо снять

**CZ** V případě, že vozidlo je vybaveno vnitřním stropem musí být tento před montáží odmontován.

**SLO** Pred pritrditvanjem odstranite notranjo strešno oblogo, če jo vozilo ima.

**HU** Abban az esetben ha a rögzítés helyén belső közbetételek találunk, azt a rögzítés előtt távolítsuk el.

**한국어** 내부 루프 라이닝이 있는 경우, 설치를 시작하기 전에 분리하십시오.

**日本語** 内側に屋根の裏張りがある場合は、取付手順を開始する前に取り外してください。

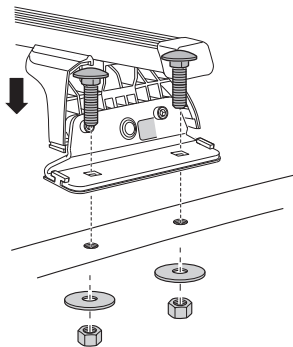
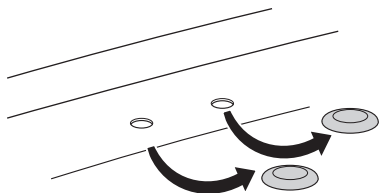
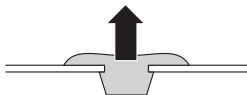
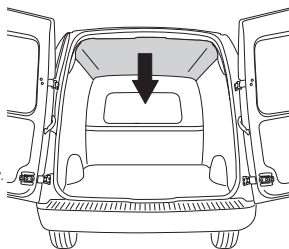

**5**

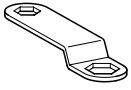

x1

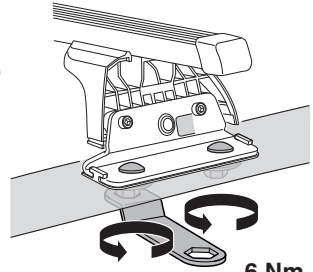
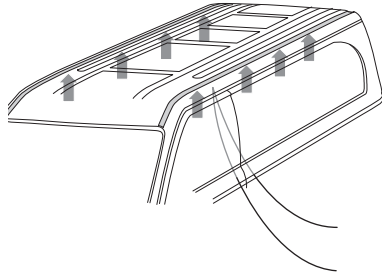

6 Nm

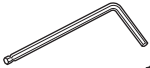

x1

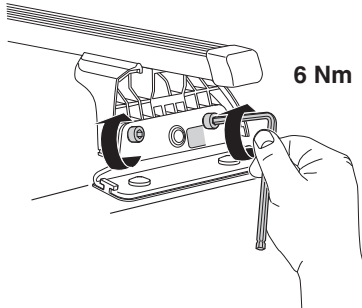

6 Nm

**6**



x4

753



x4



x1

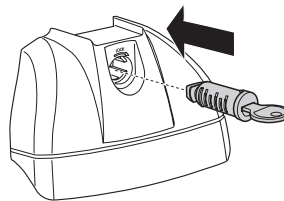

x4

460/460R



x4

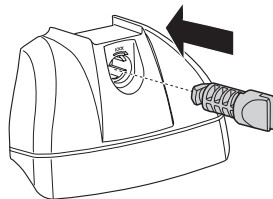



**7**



753 x4

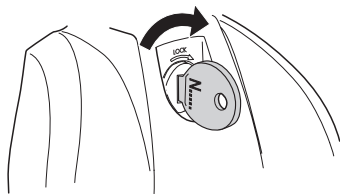
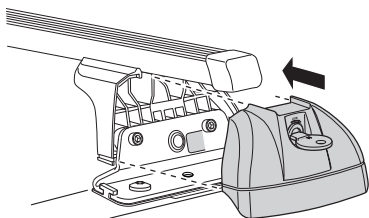

460/460R x4

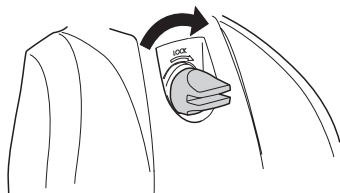
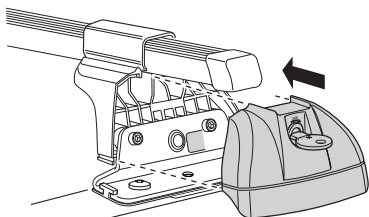

**8**

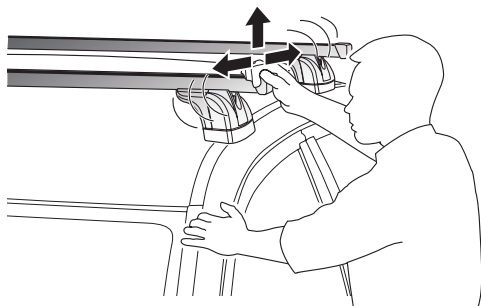





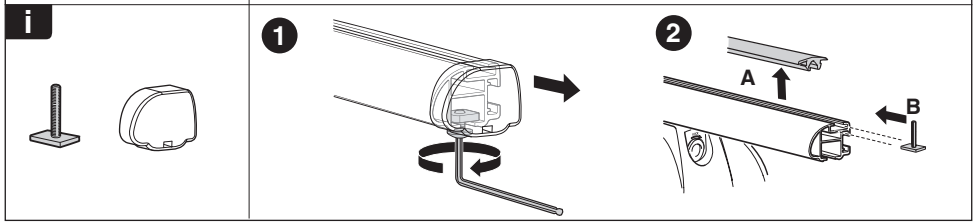
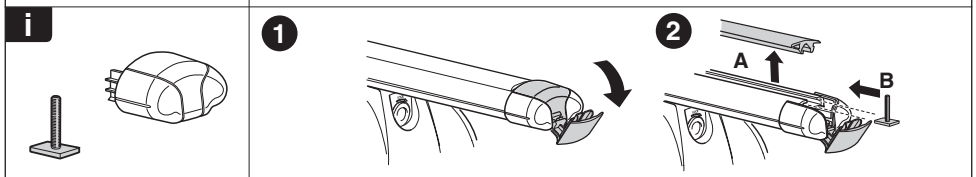
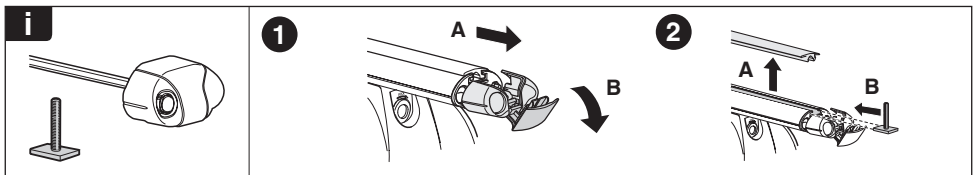
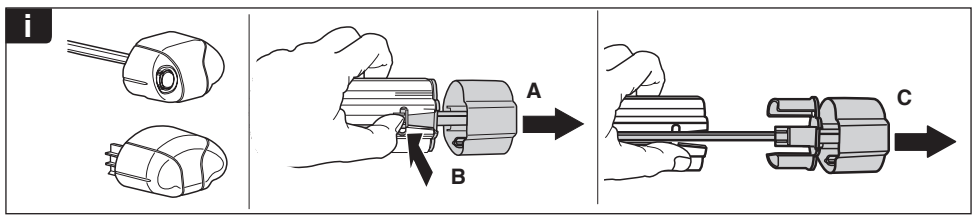
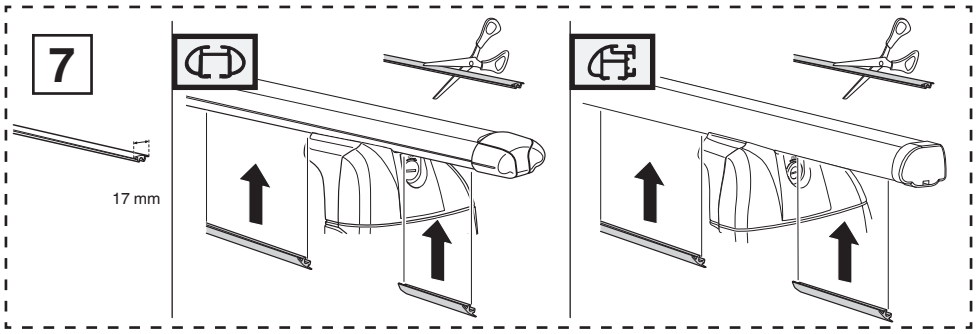



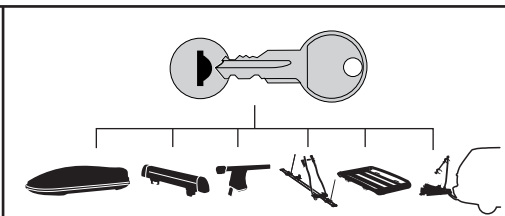



**THULE**  
SWEDEN  
**ONE  
KEY  
SYSTEM**



- 544**  (x4)
- 596**  (x6)
- 588**  (x8)
- NA 510**  (x10)
- EUR ASIA 452**  (x12)