

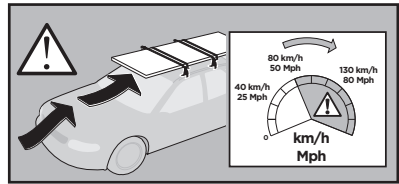

# Thule Rapid System Kit 1863

# > Instructions

VOLKSWAGEN Arteon, 4-dr Coupé, 17-

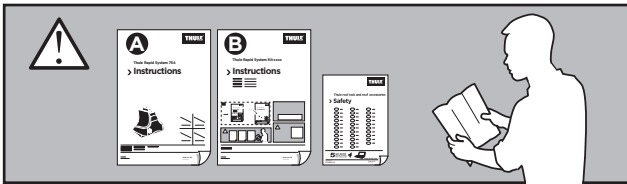
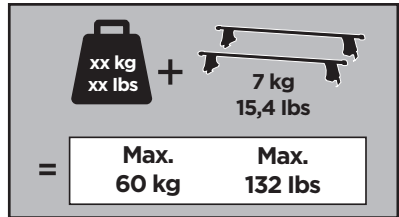
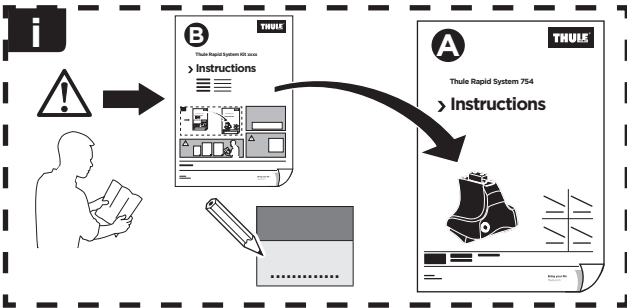
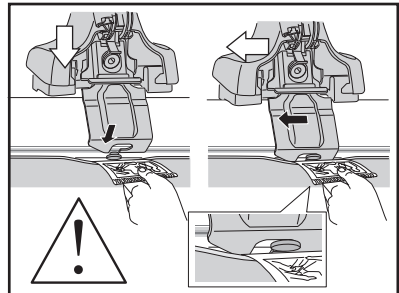
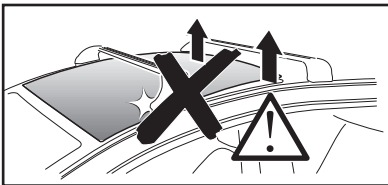

ISO 11154-E

141863

C.20170614  
519-1863-01

Bring your life  
thule.com



78 x1 ▶

79 x1 ▶

165 x1 ▶

166 x1 ▶

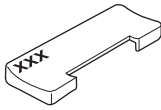

◀ 1424 x2

◀ 1425 x2



x1

52576



x2

50993

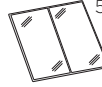

x2



x1

1

	X (scale)	X (mm)	X (inch)
<b>VOLKSWAGEN Arteon, 4-dr Coupé, 17-</b>	<b>46,5</b>	<b>1116</b>	<b>43 <sup>7</sup>/<sub>8</sub></b>

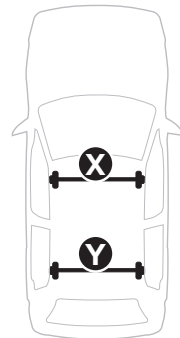
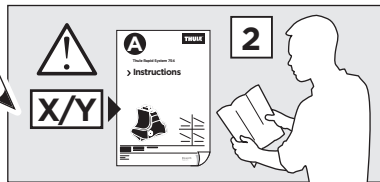
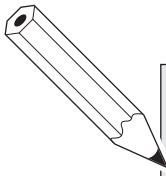

	Y (scale)	Y (mm)	Y (inch)
<b>VOLKSWAGEN Arteon, 4-dr Coupé, 17-</b>	<b>41,5</b>	<b>1066</b>	<b>42</b>

2

VOLKSWAGEN Arteon, 4-dr Coupé, 17-

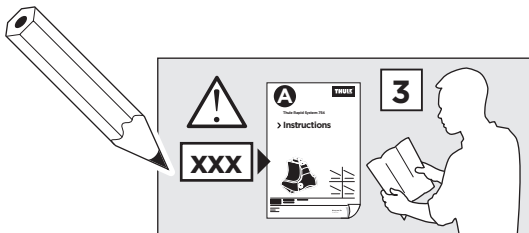
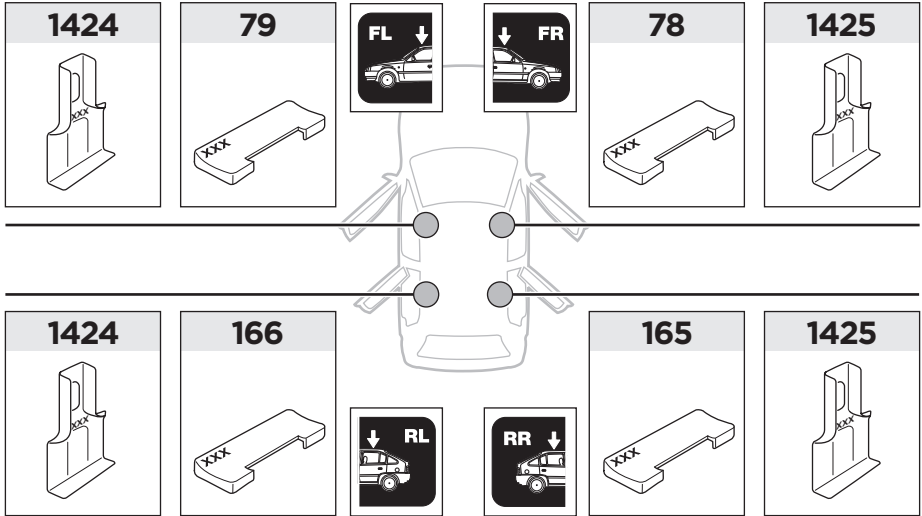

**3**

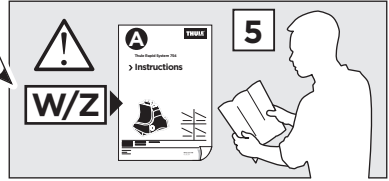

	W (mm)	Z (mm)	W (inch)	Z (inch)
<b>VOLKSWAGEN Arteon, 4-dr Coupé, 17-</b>	<b>145</b>	<b>760</b>	<b>5 <sup>3</sup>/<sub>4</sub></b>	<b>29 <sup>7</sup>/<sub>8</sub></b>

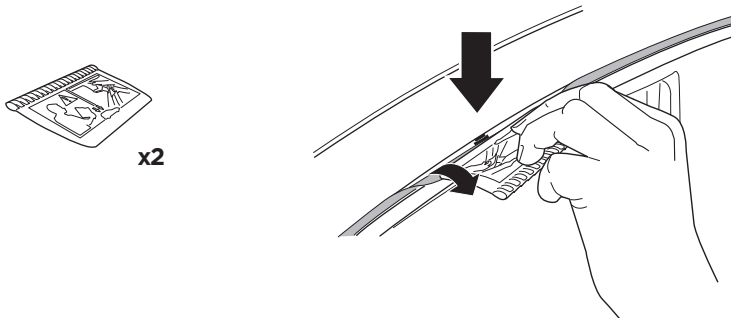
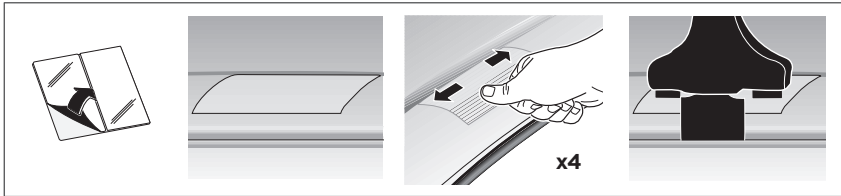
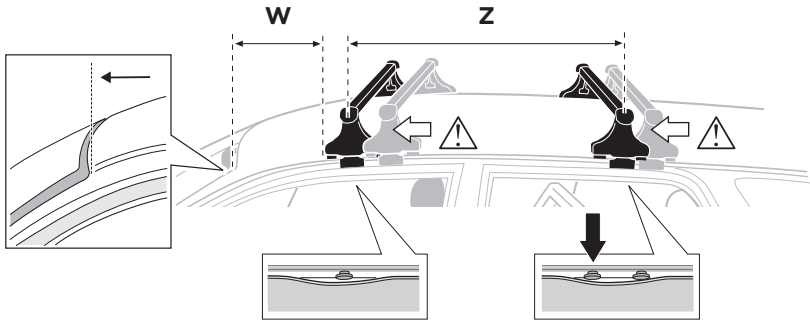

4

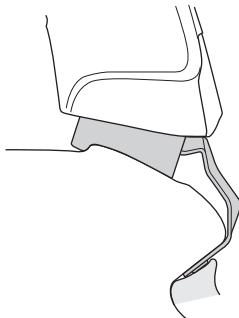
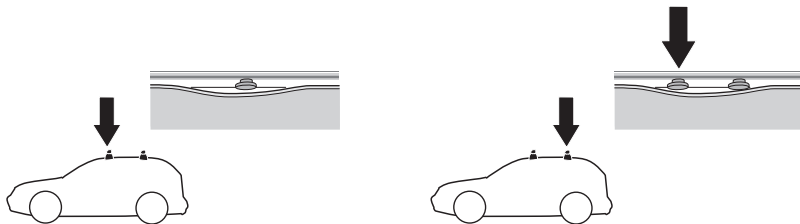
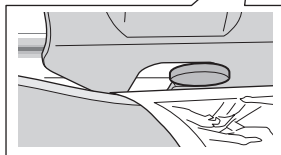
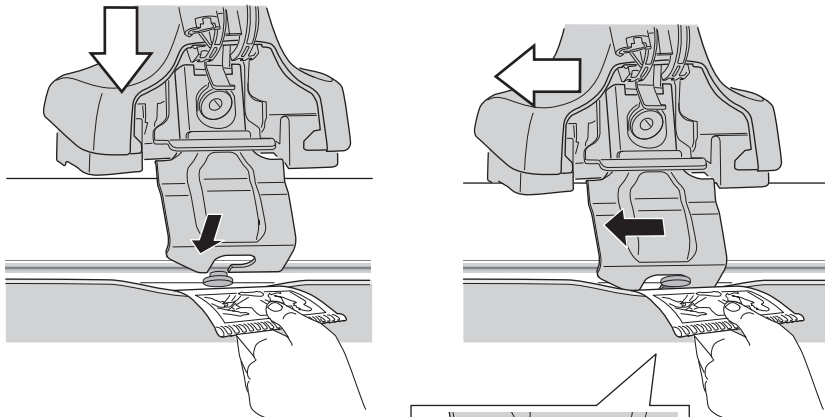







Thule Sweden AB, Borggatan 5, 335 73 Hillerstorp, SWEDEN  
Thule Inc., 42 Silvermine Road, Seymour, Connecticut 06483, USA



[info@thule.com](mailto:info@thule.com)  
Phone: 800-238-2388



[www.thule.com](http://www.thule.com)