

F PORTE VELOS ARRIERE POUR DISPOSITIF D'ATTELAGE

I PORTACICLO POSTERIORE GANCIO DI TRAINO

GB THE REAR CYCLE RACK FOR MOUNTING ON TOW BAR

E PORTA BICICLETA PARA APLICAR A LA BOLA DE REMOLQUE

P UCHWYT ROWEROWY MOCOWANY NA HAKU

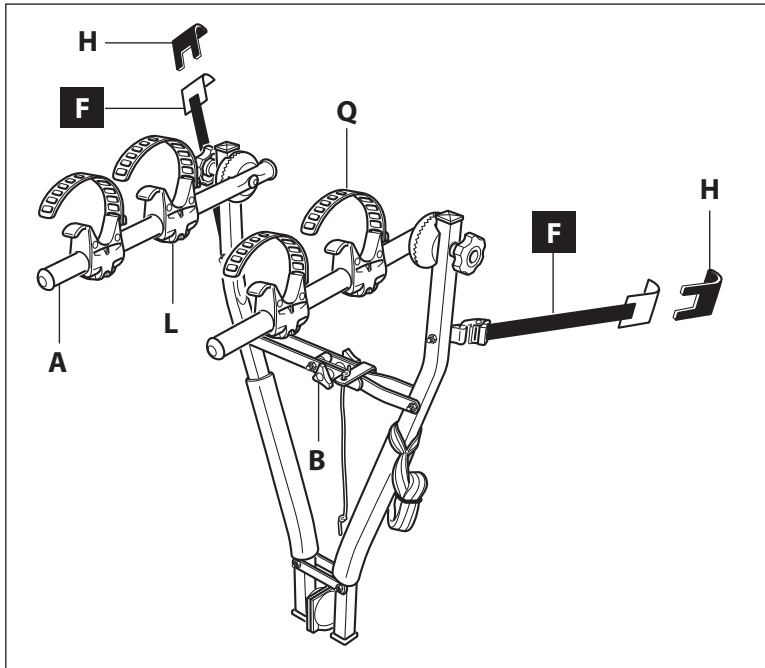

DETAIL	Pcs.	REF.	DETAIL	Pcs.
	1	A		2
	1	B		1
		F		2
		H		2
		L		4
		Q		4
		T		4
		U		4

1 MONTAGE DU PORTE-VELO
MONTAGGIO PORTACICLO
BICYCLE CARRIER INSTALLATION
MONTAJE PORTA BICICLETA

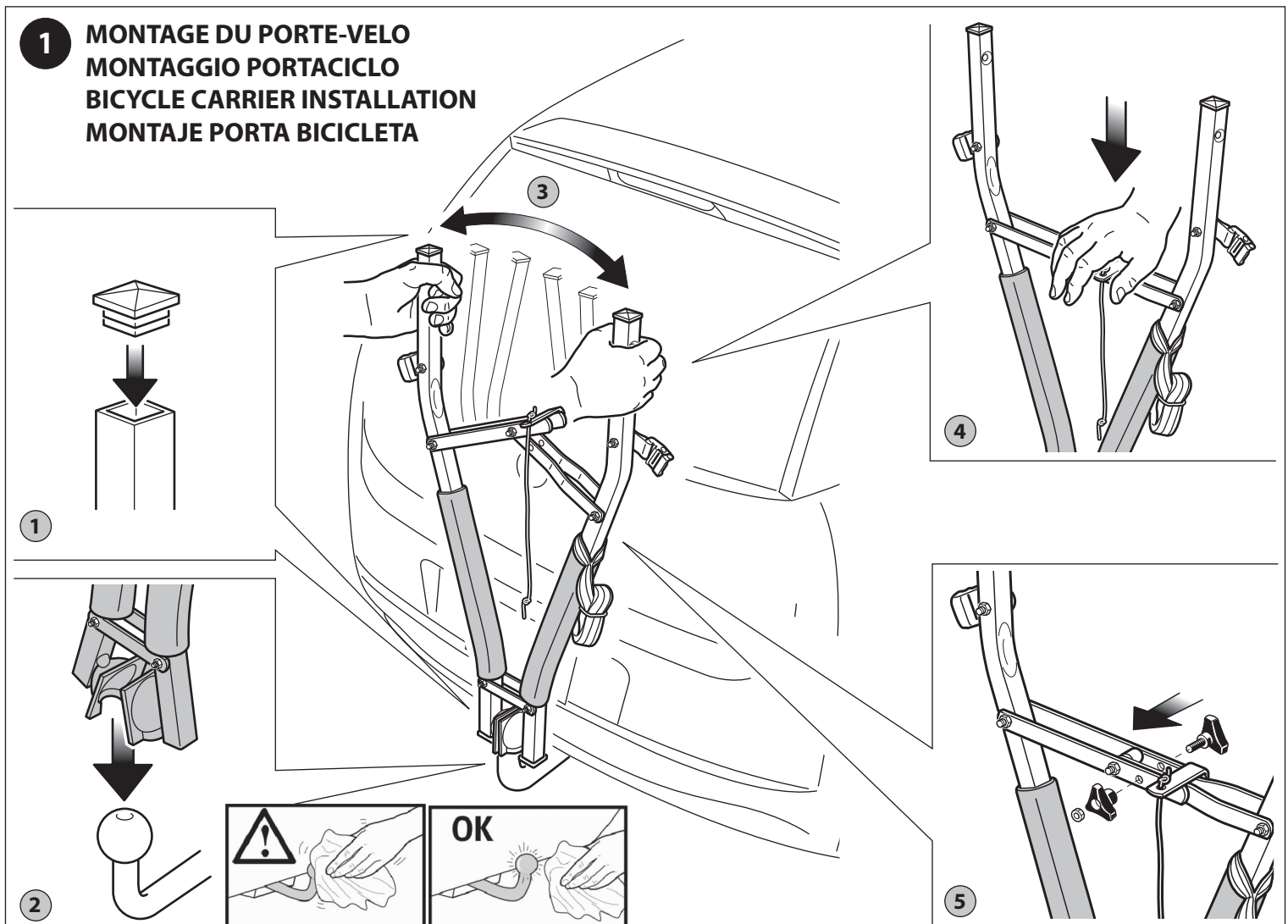

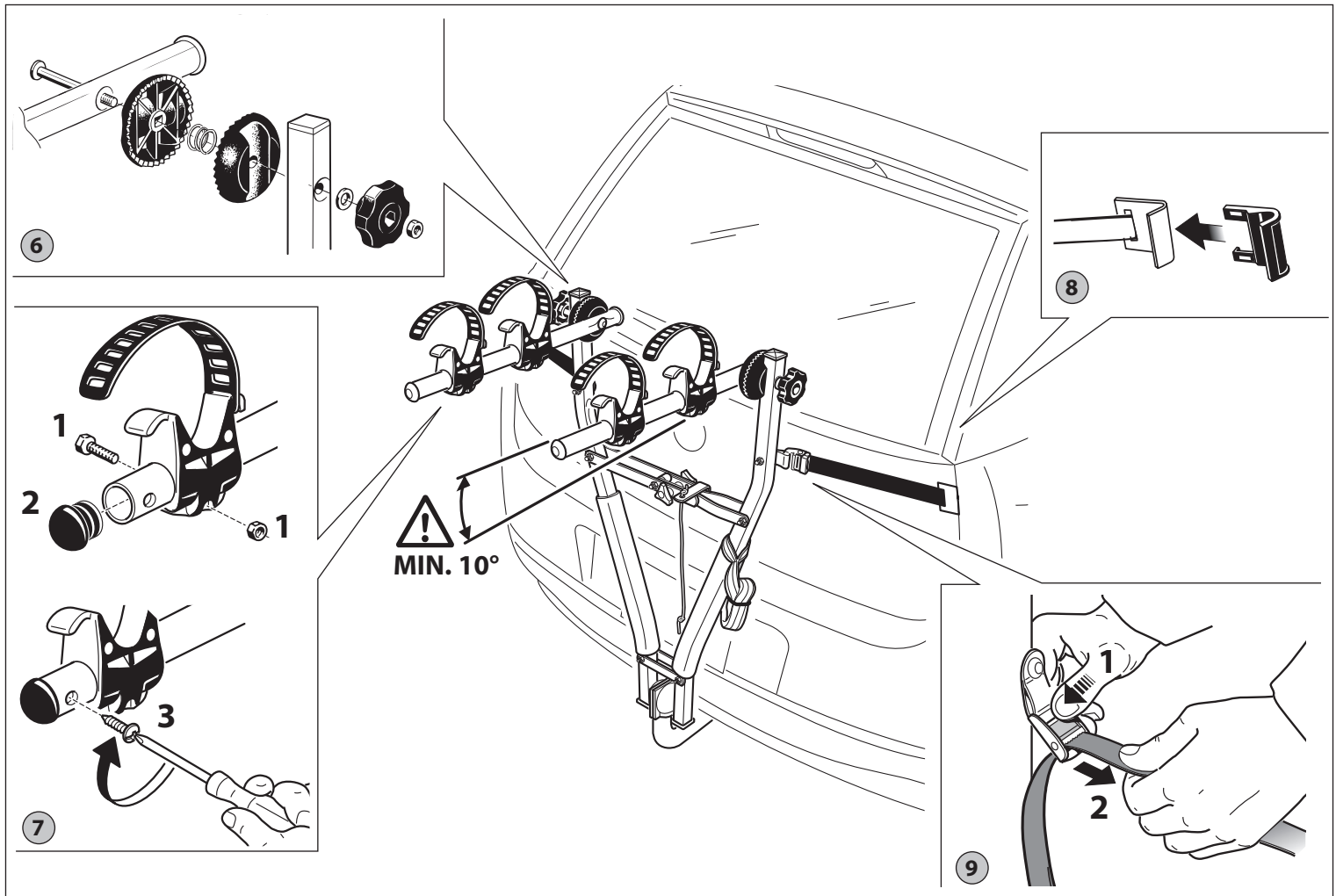

2 FIXATION DES VELOS
 FISSAGGIO BICICLETTE
 FIXING BICYCLES
 FIJACION DE BICICLETAS

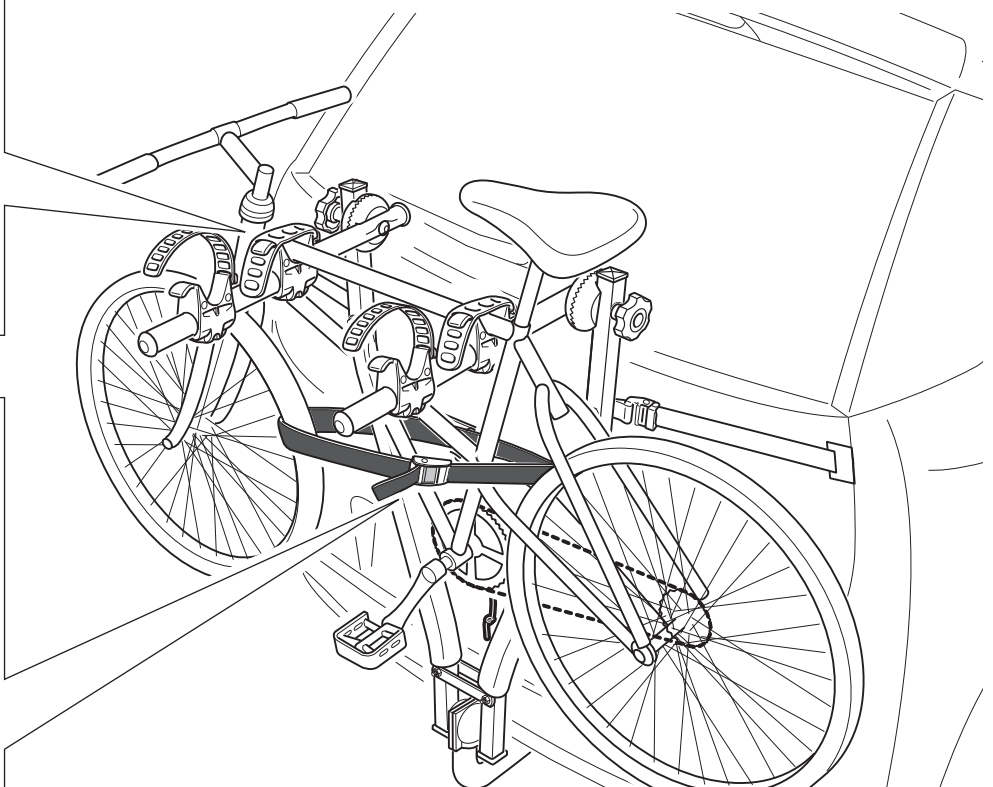
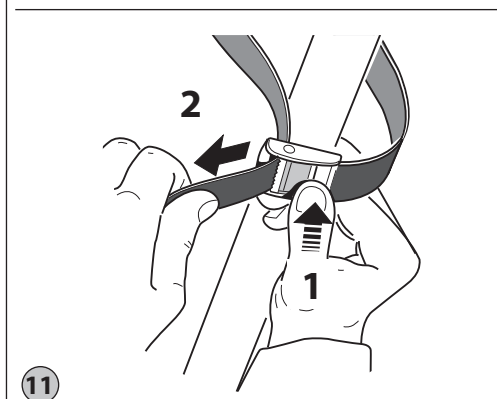
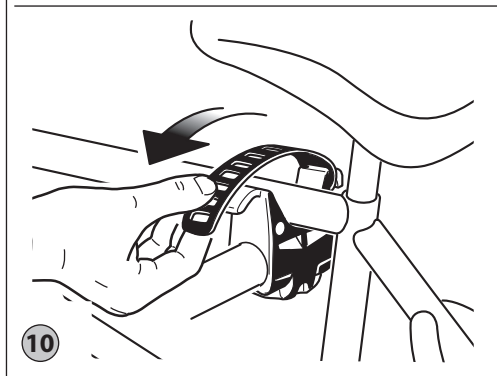
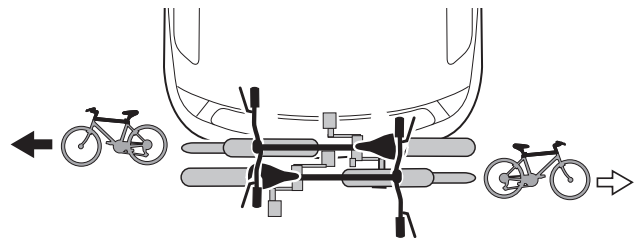

**3 DEMONTAGE DU PORTE-VELO
RIMOZIONE PORTACICLO
BICYCLE CARRIER DISASSEMBLY
DESMONTJE PORTA BICICLETA**

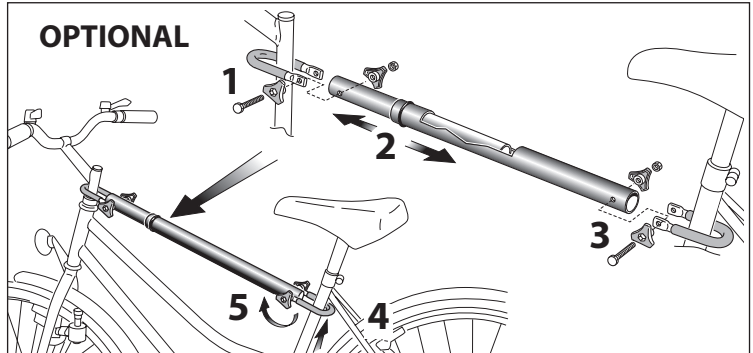
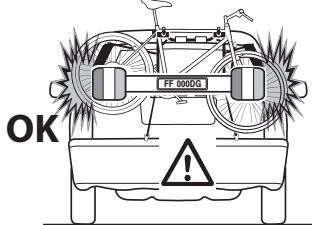
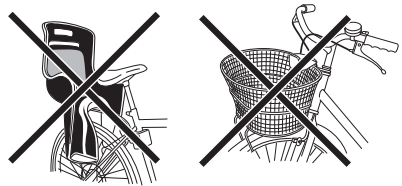
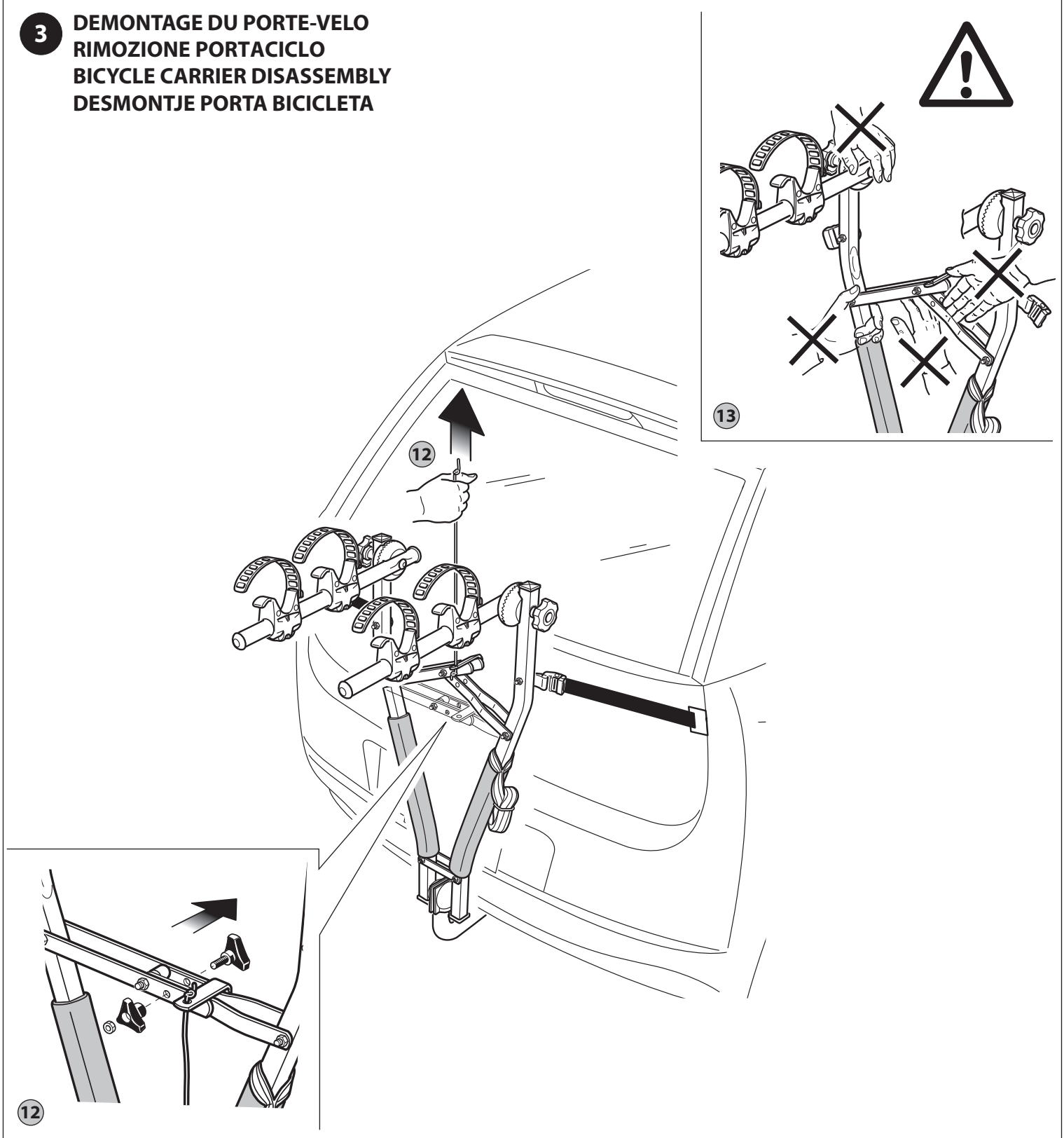

90MAX