

SC 71 105 031

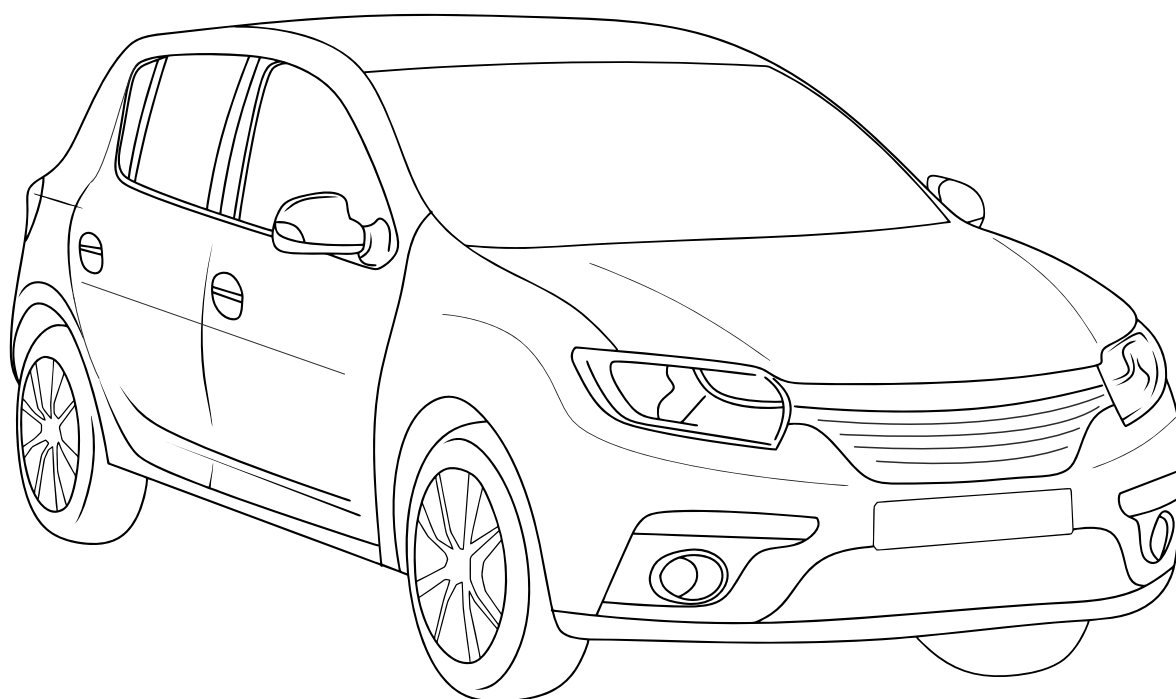

7-
(9200-76)



Renault Sandero 2014-

- 1.
- 2.

3.

4.

!

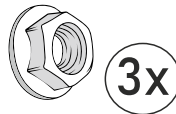
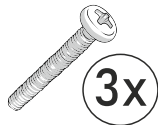
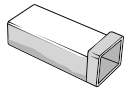
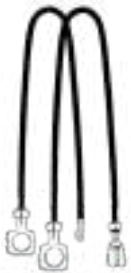
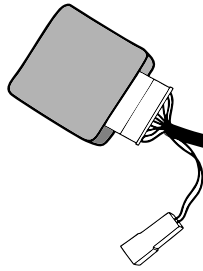
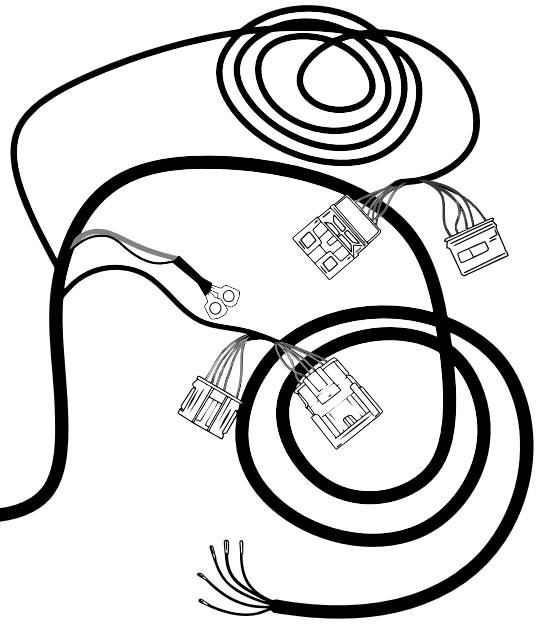
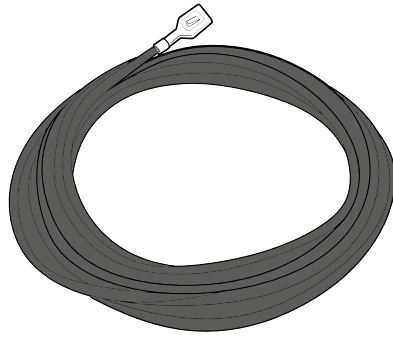
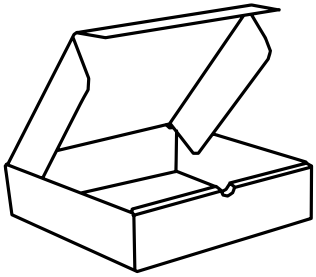

!

!

!

(CODE ())

() !

, CODE

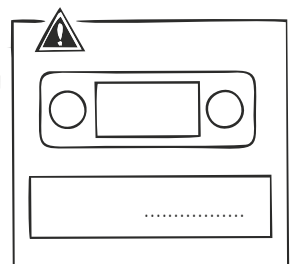
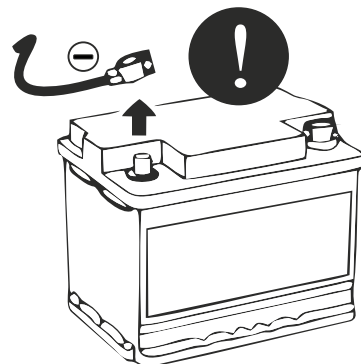

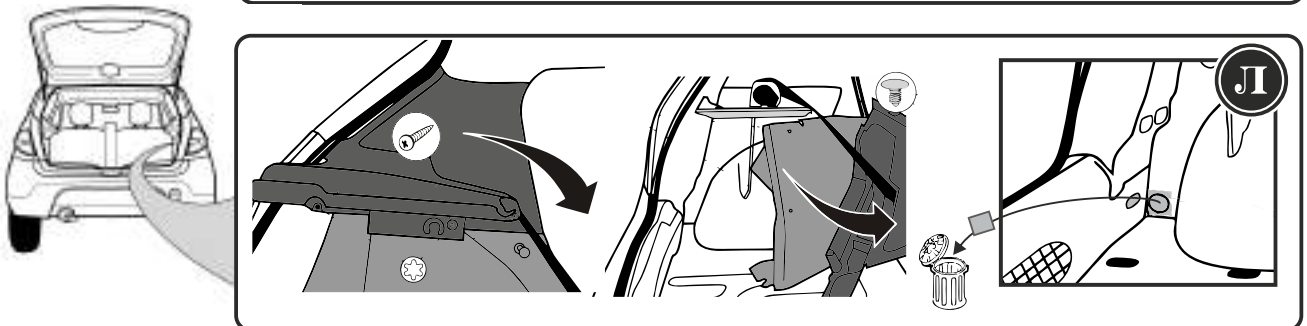
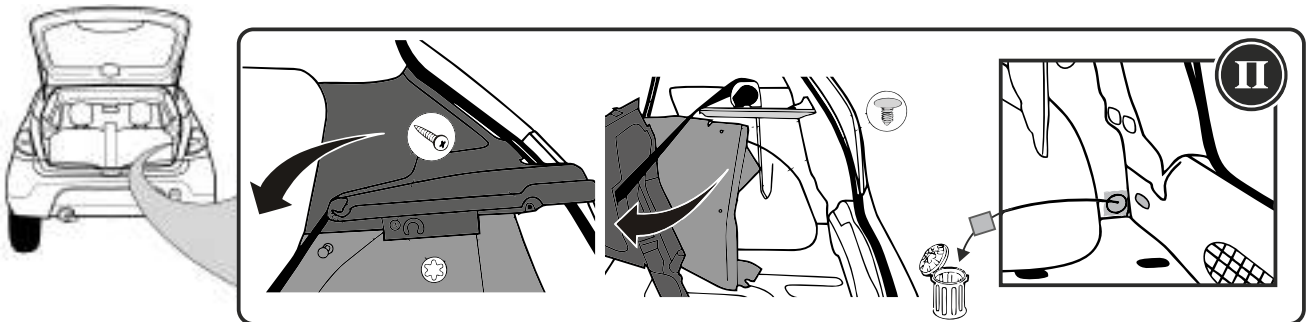
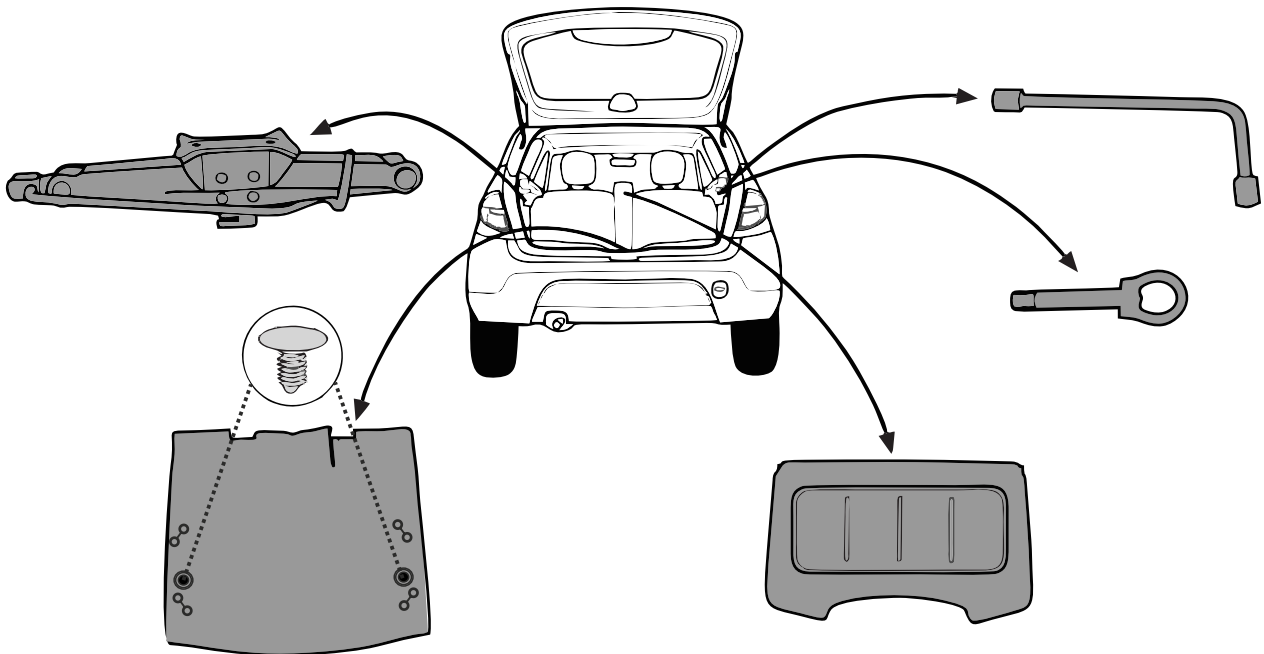
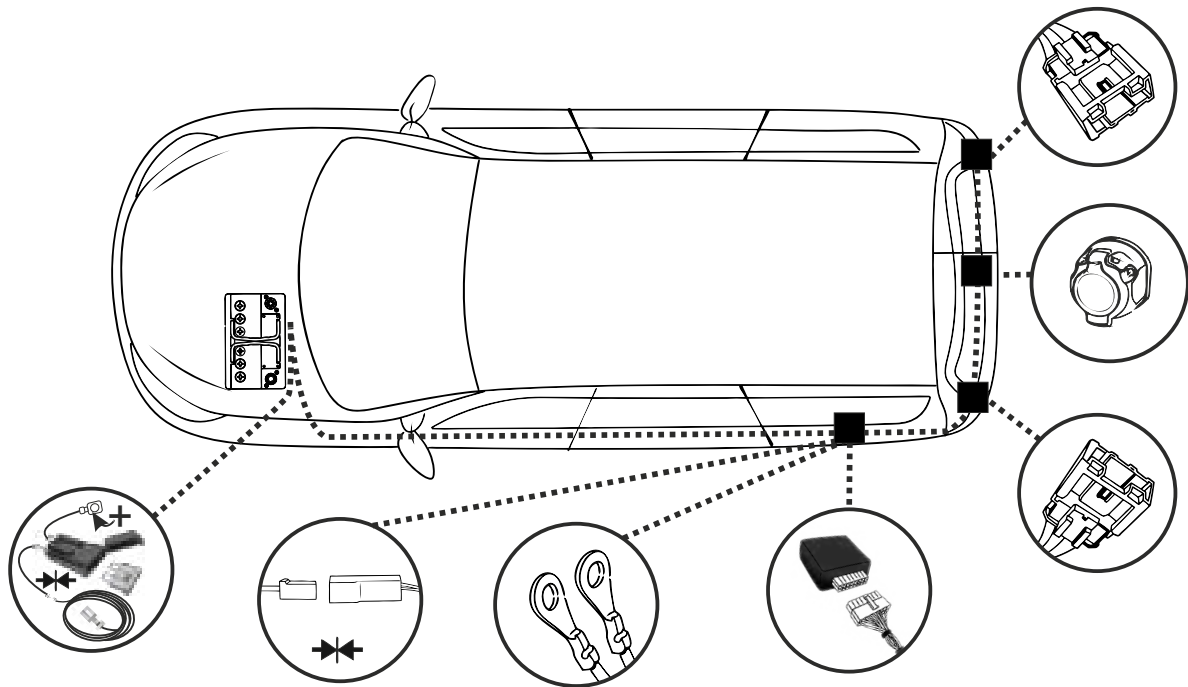

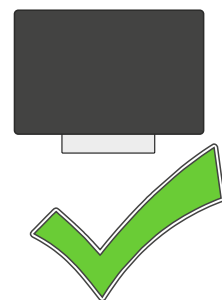
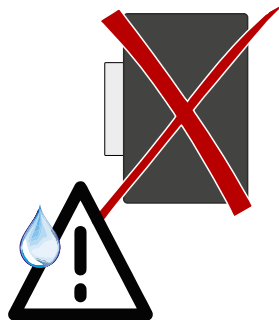
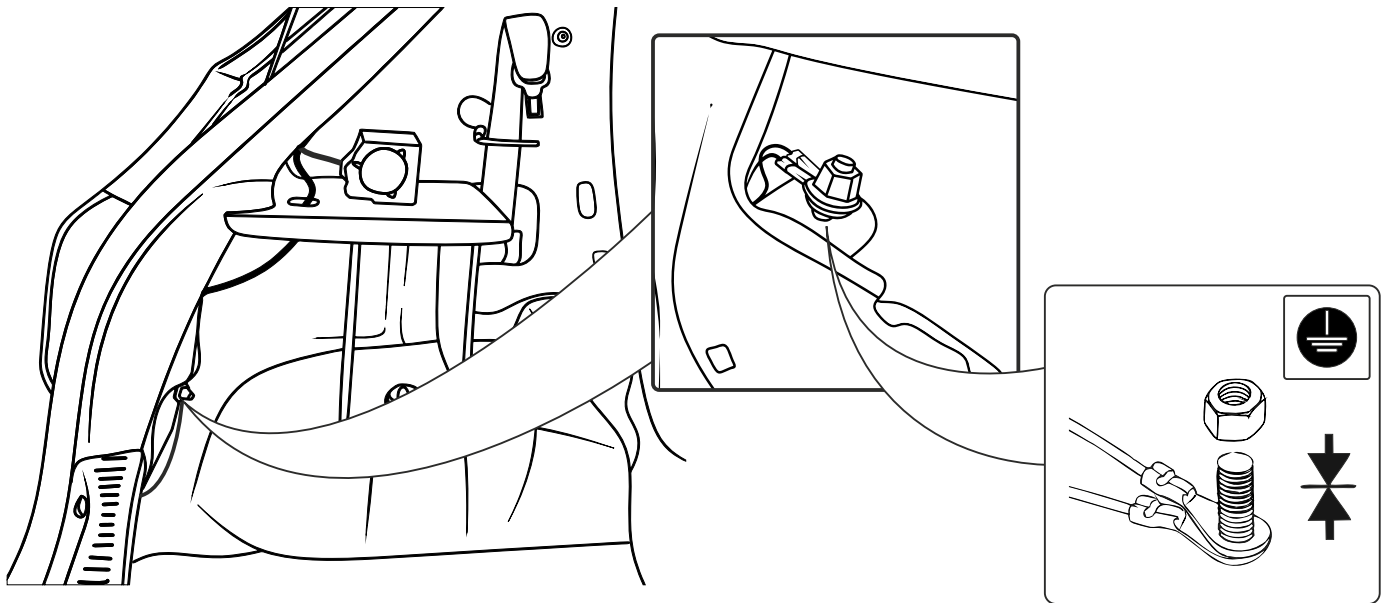
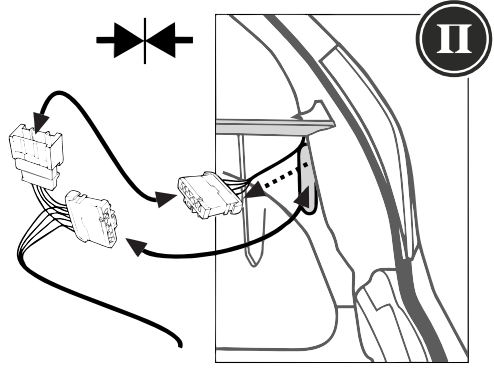
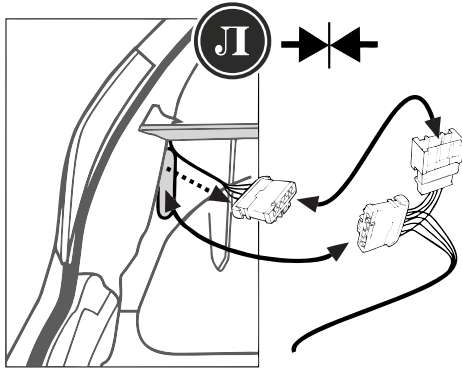
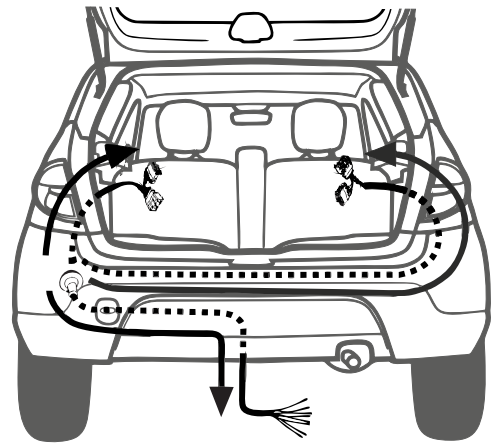
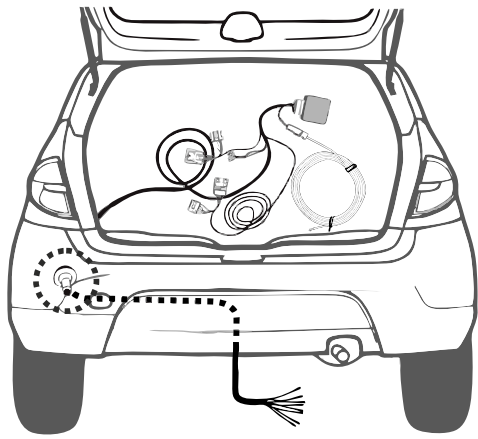

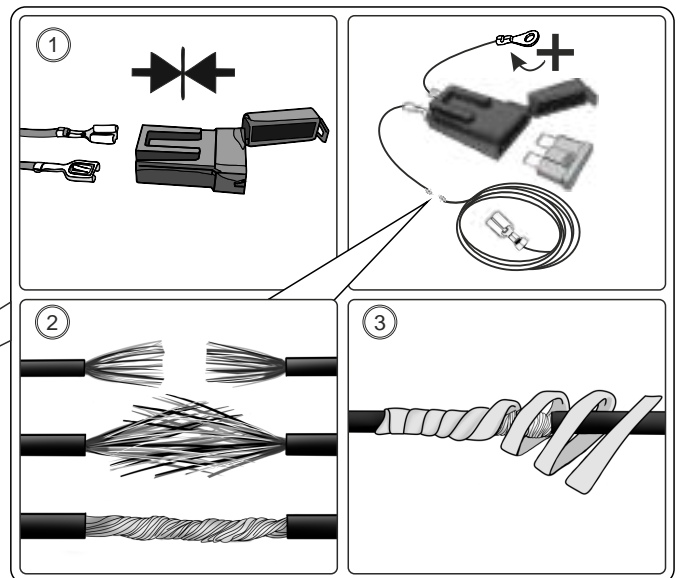
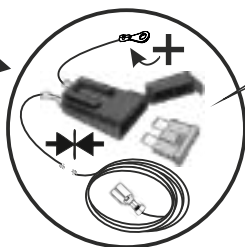
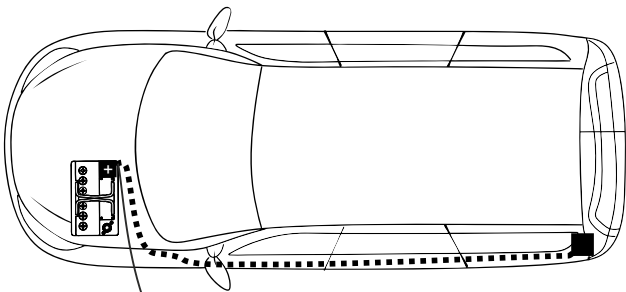
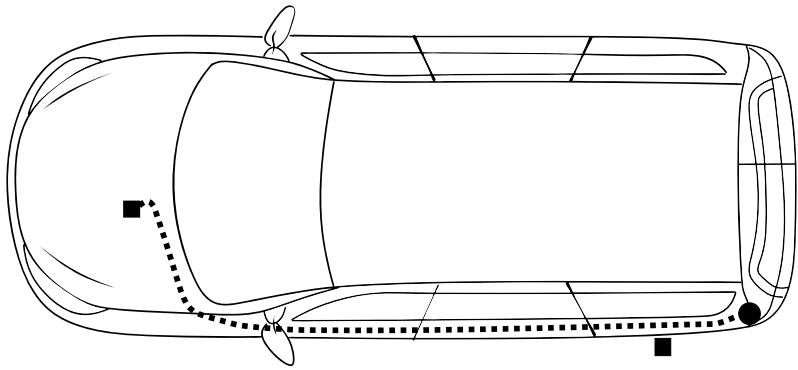
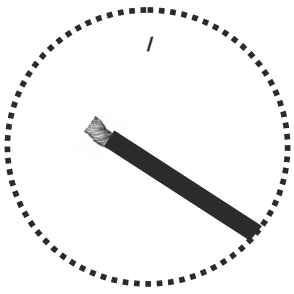
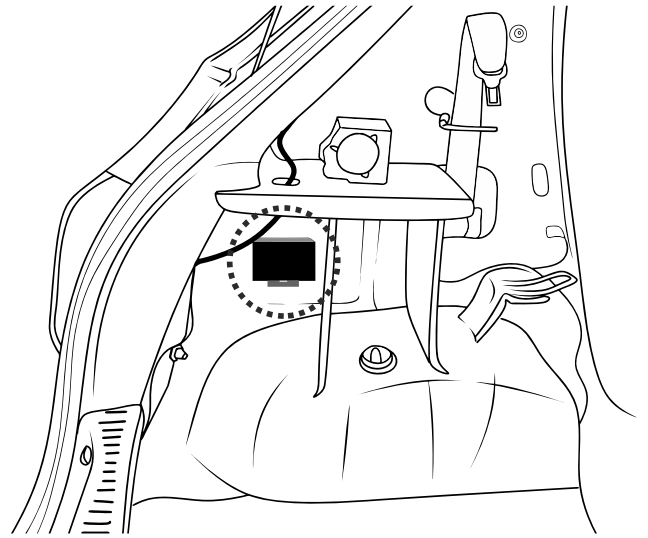
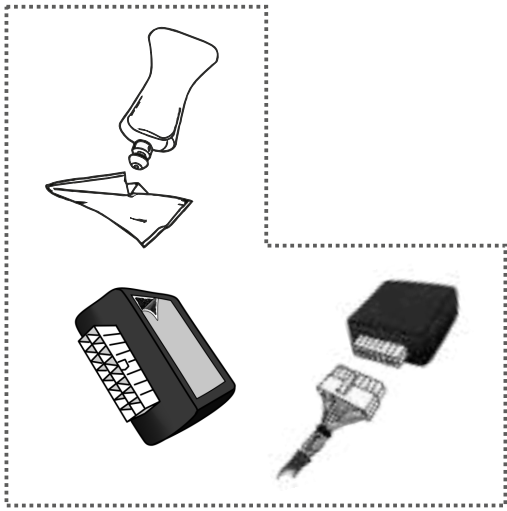

*

9200-76

| | | | | | | |
|-----|-------|------|-----|--------|-------|--------|
| | | | | | | |
| 1/L | 2 | 3/31 | 4/R | 5/58-R | 6/54 | 7/58-L |
| 21W | 2x21W | | 21W | 21W | 2x21W | 21W |
| | | | | - | | |

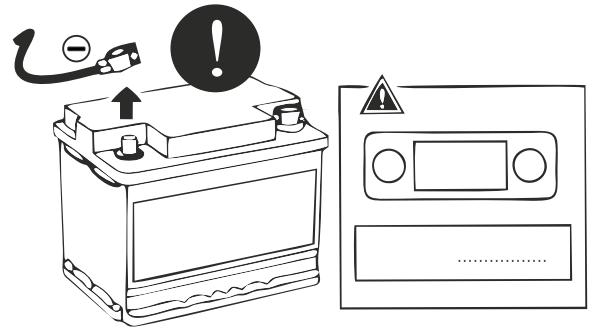
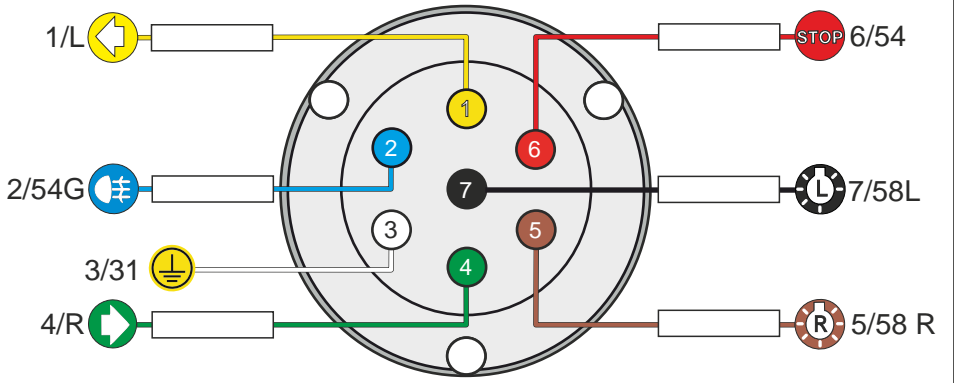
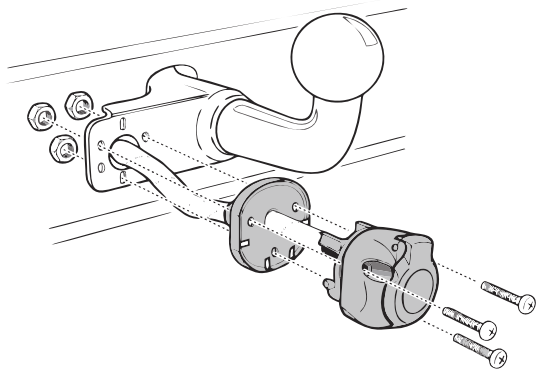

[]

